

3 W filter-free class-D audio power amplifier

Datasheet - production data

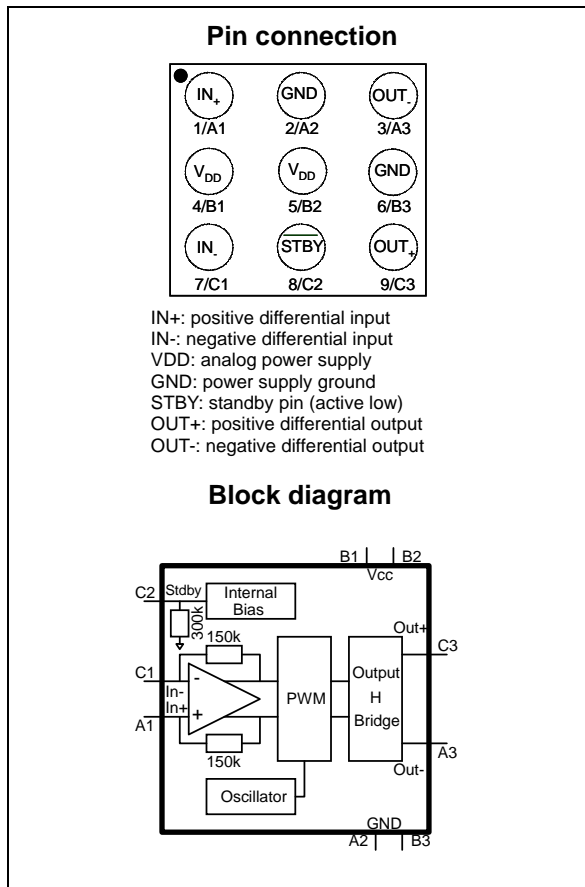

- Output power: 1.4 W @ 5 V or 0.45 W @ 3 V into 8 Ω with 1% THD+N max
- Adjustable gain via external resistors
- Low current consumption 2 mA @ 3 V
- Efficiency: 88% typ.
- Signal to noise ratio: 85 dB typ.
- PSRR: 63 dB typ. @ 217 Hz with 6 dB gain
- PWM base frequency: 250 kHz
- Low pop & click noise
- Thermal shutdown protection
- Available in flip-chip 9 x 300 μm (Pb-free)

Applications

- Wearable
- Fitness and healthcare
- Cellular phone
- PDA

Description

The A21SP16 is a differential class-D BTL power amplifier. It is able to drive up to 2.3 W into a 4 Ω load and 1.4 W into a 8 Ω load at 5 V. It achieves outstanding efficiency (88% typ.) compared to classical Class-AB audio amps.

The gain of the device can be controlled via two external gain-setting resistors. Pop & click reduction circuitry provides low on/off switch noise while allowing the device to start within 5 ms. A standby function (active low) allows the reduction of current consumption to 10 nA typ.

Features

- Operating from $V_{CC} = 2.4 \text{ V}$ to 5.5 V
- Standby mode active low
- Output power: 3 W into 4 Ω and 1.75 W into 8 Ω with 10% THD+N max and 5 V power supply
- Output power: 2.3 W @ 5 V or 0.75 W @ 3 V into 4 Ω with 1% THD+N max

Table 1. Order codes

Part number	Temperature range	Package	Packing	Marking
A21SP16	-40 °C to +85 °C	Lead-free flip-chip	Tape & reel	62

Contents

- 1 Absolute maximum ratings 3**
- 2 Application component information 4**
- 3 Electrical characteristics 5**
- 4 Electrical characteristic curves 16**
- 5 Application information 27**
 - 5.1 Differential configuration principle 27
 - 5.2 Gain in typical application schematic 27
 - 5.3 Common mode feedback loop limitations 28
 - For example: 28
 - 5.4 Low frequency response 28
 - 5.5 Decoupling of the circuit 29
 - 5.6 Wake-up time (t_{WU}) 29
 - 5.7 Shutdown time (t_{STBY}) 29
 - 5.8 Consumption in shutdown mode 29
 - 5.9 Single-ended input configuration 29
 - 5.10 Output filter considerations 31
 - 5.11 Different examples with summed inputs 32
 - Example 1: Dual differential inputs. 32
 - Example 2: One differential input plus one single-ended input 33
- 6 Footprint recommendations 34**
- 7 Package information 35**
- 8 Revision history 36**

1 Absolute maximum ratings

Table 2. Absolute maximum ratings

Symbol	Parameter	Value	Unit
V_{CC}	Supply voltage ^{(1), (2)}	6	V
V_{in}	Input voltage ⁽³⁾	GND to V_{CC}	V
T_{oper}	Operating free-air temperature range	-40 to + 85	°C
T_{stg}	Storage temperature	-65 to +150	°C
T_j	Maximum junction temperature	150	°C
R_{thja}	Thermal resistance junction to ambient ⁽⁴⁾	200	°C/W
P_{diss}	Power dissipation	Internally limited ⁽⁵⁾	
ESD	Human body model	2	kV
ESD	Machine model	200	V
Latch-up	Latch-up immunity	200	mA
V_{STBY}	Standby pin voltage maximum voltage ⁽⁶⁾	GND to V_{CC}	V
	Lead temperature (soldering, 10 sec)	260	°C

1. Caution: This device is not protected in the event of abnormal operating conditions, such as for example, short-circuiting between any one output pin and ground, between any one output pin and V_{CC} , and between individual output pins.
2. All voltage values are measured with respect to the ground pin.
3. The magnitude of the input signal must never exceed $V_{CC} + 0.3V / GND - 0.3V$.
4. The device is protected in case of over temperature by a thermal shutdown active @ 150°C.
5. Exceeding the power derating curves during a long period causes abnormal operation.
6. The magnitude of the standby signal must never exceed $V_{CC} + 0.3V / GND - 0.3V$.

Table 3. Operating conditions

Symbol	Parameter	Value	Unit
V_{CC}	Supply voltage ⁽¹⁾	2.4 to 5.5	V
V_{IC}	Common mode input voltage range ⁽²⁾	0.5 to $V_{CC} - 0.8$	V
V_{STBY}	Standby voltage input: ⁽³⁾ Device ON Device OFF	$1.4 \leq V_{STBY} \leq V_{CC}$ $GND \leq V_{STBY} \leq 0.4$ ⁽⁴⁾	V
R_L	Load resistor	≥ 4	Ω
R_{thja}	Thermal resistance junction to ambient ⁽⁵⁾	90	°C/W

1. For V_{CC} from 2.4V to 2.5V, the operating temperature range is reduced to $0^\circ\text{C} \leq T_{amb} \leq 70^\circ\text{C}$.
2. For V_{CC} from 2.4V to 2.5V, the common mode input range must be set at $V_{CC}/2$.
3. Without any signal on V_{STBY} , the device will be in standby.
4. Minimum current consumption is obtained when $V_{STBY} = GND$.
5. With heat sink surface = 125mm².

2 Application component information

Table 4. Component information

Component	Functional description
C _s	Bypass supply capacitor. Install as close as possible to the A21SP16 to minimize high-frequency ripple. A 100nF ceramic capacitor should be added to enhance the power supply filtering at high frequency.
R _{in}	Input resistor to program the A21SP16 differential gain (gain = 300 kΩ/R _{in} with R _{in} in kΩ).
Input capacitor	Due to common mode feedback, these input capacitors are optional. However, they can be added to form with R _{in} a 1st order high pass filter with -3dB cut-off frequency = 1/(2*π*R _{in} *C _{in}).

Figure 1. Typical application schematics

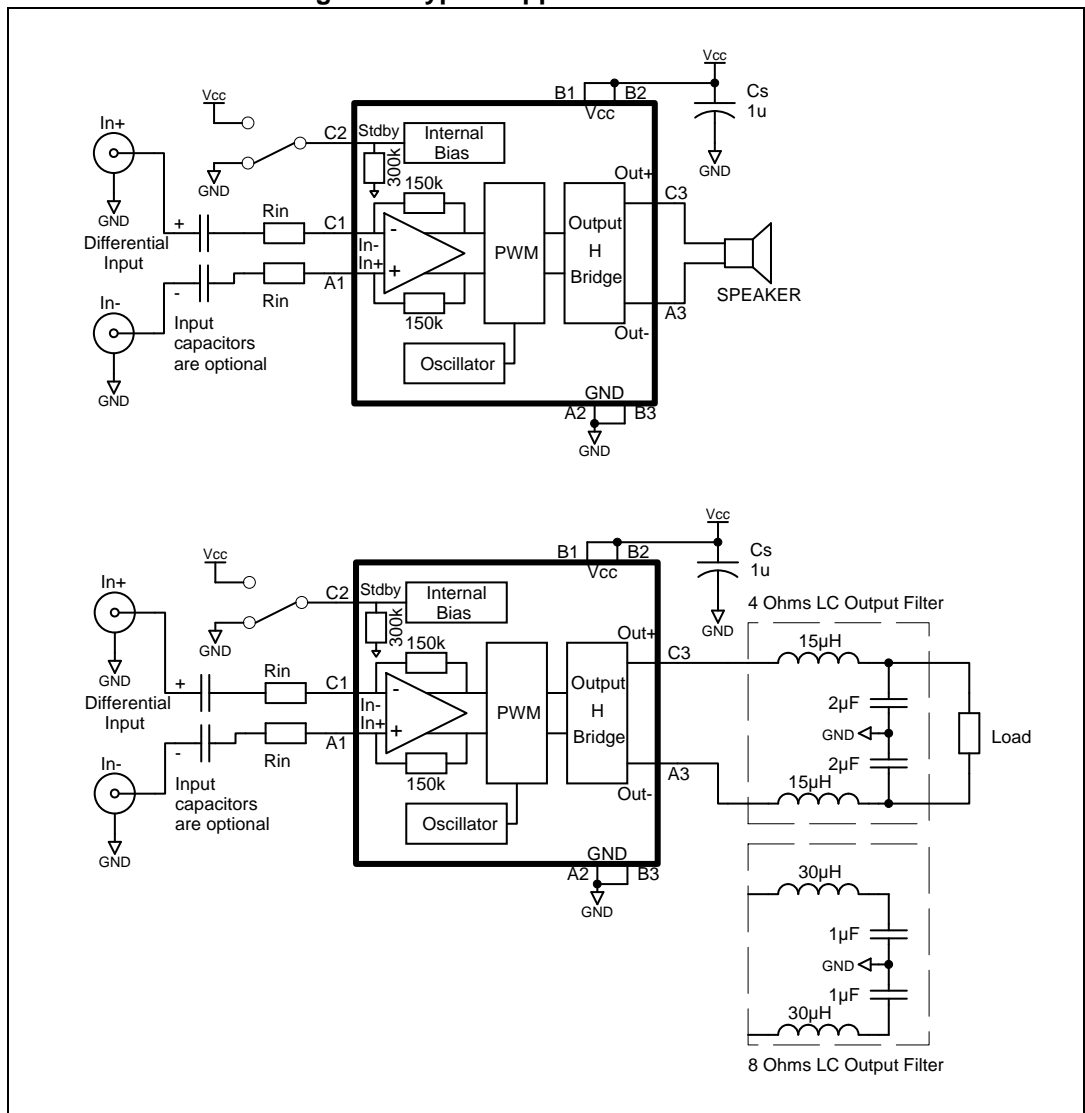

3 Electrical characteristics

Table 5. $V_{CC} = +5V$, $GND = 0V$, $V_{IC} = 2.5V$, $t_{amb} = 25^{\circ}C$ (unless otherwise specified)

Symbol	Parameter	Conditions	Min.	Typ.	Max.	Unit
I_{CC}	Supply current	No input signal, no load		2.3	3.3	mA
I_{STBY}	Standby current ⁽¹⁾	No input signal, $V_{STBY} = GND$		10	1000	nA
V_{OO}	Output offset voltage	No input signal, $R_L = 8\Omega$		3	25	mV
P_{out}	Output power	G=6dB THD = 1% max, F = 1kHz, $R_L = 4\Omega$ THD = 10% max, F = 1kHz, $R_L = 4\Omega$ THD = 1% max, F = 1kHz, $R_L = 8\Omega$ THD = 10% max, F = 1kHz, $R_L = 8\Omega$		2.3 3 1.4 1.75		W
THD + N	Total harmonic distortion + noise	$P_{out} = 900mW_{RMS}$, G = 6dB, 20Hz < F < 20kHz $R_L = 8W + 15\mu H$, BW < 30kHz $P_{out} = 1W_{RMS}$, G = 6dB, F = 1kHz, $R_L = 8W + 15\mu H$, BW < 30kHz		1 0.4		%
Efficiency	Efficiency	$P_{out} = 2W_{RMS}$, $R_L = 4\Omega + \geq 15\mu H$ $P_{out} = 1.2W_{RMS}$, $R_L = 8\Omega + \geq 15\mu H$		78 88		%
PSRR	Power supply rejection ratio with inputs grounded ⁽²⁾	F = 217Hz, $R_L = 8\Omega$, G=6dB, $V_{ripple} = 200mV_{pp}$		63		dB
CMRR	Common mode rejection ratio	F = 217Hz, $R_L = 8\Omega$, G = 6dB, $\Delta V_{icm} = 200mV_{pp}$		57		dB
Gain	Gain value	R_{in} in k Ω	$\frac{273k\Omega}{R_{in}}$	$\frac{300k\Omega}{R_{in}}$	$\frac{327k\Omega}{R_{in}}$	V/V
R_{STBY}	Internal resistance from Standby to GND		273	300	327	k Ω
F_{PWM}	Pulse width modulator base frequency		180	250	320	kHz
SNR	Signal to noise ratio	A-weighting, $P_{out} = 1.2W$, $R_L = 8\Omega$		85		dB
t_{WU}	Wake-up time			5	10	ms
t_{STBY}	Standby time			5	10	ms

Table 5. $V_{CC} = +5V$, $GND = 0V$, $V_{IC} = 2.5V$, $t_{amb} = 25^{\circ}C$ (unless otherwise specified) (continued)

Symbol	Parameter	Conditions	Min.	Typ.	Max.	Unit
V_N	Output voltage noise	F = 20Hz to 20kHz, G = 6dB Unweighted $R_L = 4\Omega$ A-weighted $R_L = 4\Omega$		85 60		μV_{RMS}
		Unweighted $R_L = 8\Omega$ A-weighted $R_L = 8\Omega$		86 62		
		Unweighted $R_L = 4\Omega + 15\mu H$ A-weighted $R_L = 4\Omega + 15\mu H$		83 60		
		Unweighted $R_L = 4\Omega + 30\mu H$ A-weighted $R_L = 4\Omega + 30\mu H$		88 64		
		Unweighted $R_L = 8\Omega + 30\mu H$ A-weighted $R_L = 8\Omega + 30\mu H$		78 57		
		Unweighted $R_L = 4\Omega + \text{Filter}$ A-weighted $R_L = 4\Omega + \text{Filter}$		87 65		
		Unweighted $R_L = 4\Omega + \text{Filter}$ A-weighted $R_L = 4\Omega + \text{Filter}$		82 59		

1. Standby mode is active when V_{STBY} is tied to GND.
2. Dynamic measurements - $20 \cdot \log(\text{rms}(V_{out})/\text{rms}(V_{ripple}))$. V_{ripple} is the superimposed sinusoidal signal to V_{CC} @ F = 217Hz.

Table 6. $V_{CC} = +4.2V$, $GND = 0V$, $V_{IC} = 2.5V$, $T_{amb} = 25^{\circ}C$ (unless otherwise specified)⁽¹⁾

Symbol	Parameter	Conditions	Min.	Typ.	Max.	Unit
I_{CC}	Supply current	No input signal, no load		2.1	3	mA
I_{STBY}	Standby current ⁽²⁾	No input signal, $V_{STBY} = GND$		10	1000	nA
V_{OO}	Output offset voltage	No input signal, $R_L = 8\Omega$		3	25	mV
P_{out}	Output power	G=6dB THD = 1% max, F = 1kHz, $R_L = 4\Omega$ THD = 10% max, F = 1kHz, $R_L = 4\Omega$ THD = 1% max, F = 1kHz, $R_L = 8\Omega$ THD = 10% max, F = 1kHz, $R_L = 8\Omega$		1.6 2 0.95 1.2		W
THD + N	Total harmonic distortion + noise	$P_{out} = 600mW_{RMS}$, G = 6dB, $20Hz < F < 20kHz$ $R_L = 8\Omega + 15\mu H$, BW < 30kHz $P_{out} = 700mW_{RMS}$, G = 6dB, F = 1kHz, $R_L = 8\Omega + 15\mu H$, BW < 30kHz		1 0.35		%
Efficiency	Efficiency	$P_{out} = 1.45W_{RMS}$, $R_L = 4\Omega + \geq 15\mu H$ $P_{out} = 0.9W_{RMS}$, $R_L = 8\Omega + \geq 15\mu H$		78 88		%
PSRR	Power supply rejection ratio with inputs grounded ⁽³⁾	F = 217Hz, $R_L = 8\Omega$, G=6dB, $V_{ripple} = 200mV_{pp}$		63		dB
CMRR	Common mode rejection ratio	F = 217Hz, $R_L = 8\Omega$, G = 6dB, $\Delta V_{icm} = 200mV_{pp}$		57		dB
Gain	Gain value	R_{in} in k Ω	$\frac{273k\Omega}{R_{in}}$	$\frac{300k\Omega}{R_{in}}$	$\frac{327k\Omega}{R_{in}}$	V/V
R_{STBY}	Internal resistance from Standby to GND		273	300	327	k Ω
F_{PWM}	Pulse width modulator base frequency		180	250	320	kHz
SNR	Signal to noise ratio	A-weighting, $P_{out} = 0.9W$, $R_L = 8\Omega$		85		dB
t_{WU}	Wake-up time			5	10	ms
t_{STBY}	Standby time			5	10	ms

Table 6. $V_{CC} = +4.2V$, $GND = 0V$, $V_{IC} = 2.5V$, $T_{amb} = 25^{\circ}C$ (unless otherwise specified)⁽¹⁾ (continued)

Symbol	Parameter	Conditions	Min.	Typ.	Max.	Unit
V_N	Output voltage noise	F = 20Hz to 20kHz, G = 6dB Unweighted $R_L = 4\Omega$ A-weighted $R_L = 4\Omega$		85 60		μV_{RMS}
		Unweighted $R_L = 8\Omega$ A-weighted $R_L = 8\Omega$		86 62		
		Unweighted $R_L = 4\Omega + 15\mu H$ A-weighted $R_L = 4\Omega + 15\mu H$		83 60		
		Unweighted $R_L = 4\Omega + 30\mu H$ A-weighted $R_L = 4\Omega + 30\mu H$		88 64		
		Unweighted $R_L = 8\Omega + 30\mu H$ A-weighted $R_L = 8\Omega + 30\mu H$		78 57		
		Unweighted $R_L = 4\Omega + \text{Filter}$ A-weighted $R_L = 4\Omega + \text{Filter}$		87 65		
		Unweighted $R_L = 4\Omega + \text{Filter}$ A-weighted $R_L = 4\Omega + \text{Filter}$		82 59		

1. All electrical values are guaranteed with correlation measurements at 2.5 V and 5 V.
2. Standby mode is active when V_{STBY} is tied to GND.
3. Dynamic measurements - $20 \cdot \log(\text{rms}(V_{out})/\text{rms}(V_{ripple}))$. V_{ripple} is the superimposed sinusoidal signal to V_{CC} @ $F = 217\text{Hz}$.

Table 7. $V_{CC} = +3.6V$, $GND = 0V$, $V_{IC} = 2.5V$, $T_{amb} = 25^{\circ}C$ (unless otherwise specified)⁽¹⁾

Symbol	Parameter	Conditions	Min.	Typ.	Max.	Unit
I_{CC}	Supply current	No input signal, no load		2	2.8	mA
I_{STBY}	Standby current ⁽²⁾	No input signal, $V_{STBY} = GND$		10	1000	nA
V_{OO}	Output offset voltage	No input signal, $R_L = 8\Omega$		3	25	mV
P_{out}	Output power	G=6dB THD = 1% max, F = 1kHz, $R_L = 4\Omega$ THD = 10% max, F = 1kHz, $R_L = 4\Omega$ THD = 1% max, F = 1kHz, $R_L = 8\Omega$ THD = 10% max, F = 1kHz, $R_L = 8\Omega$		1.15 1.51 0.7 0.9		W
THD + N	Total harmonic distortion + noise	$P_{out} = 500mW_{RMS}$, G = 6dB, 20Hz < F < 20kHz $R_L = 8\Omega + 15\mu H$, BW < 30kHz $P_{out} = 500mW_{RMS}$, G = 6dB, F = 1kHz, $R_L = 8\Omega + 15\mu H$, BW < 30kHz		1 0.27		%
Efficiency	Efficiency	$P_{out} = 1W_{RMS}$, $R_L = 4\Omega + \geq 15\mu H$ $P_{out} = 0.65W_{RMS}$, $R_L = 8\Omega + \geq 15\mu H$		78 88		%
PSRR	Power supply rejection ratio with inputs grounded ⁽³⁾	F = 217Hz, $R_L = 8\Omega$, G=6dB, $V_{ripple} = 200mV_{pp}$		62		dB
CMRR	Common mode rejection ratio	F = 217Hz, $R_L = 8\Omega$, G = 6dB, $\Delta V_{icm} = 200mV_{pp}$		56		dB
Gain	Gain value	R_{in} in k Ω	$\frac{273k\Omega}{R_{in}}$	$\frac{300k\Omega}{R_{in}}$	$\frac{327k\Omega}{R_{in}}$	V/V
R_{STBY}	Internal resistance from Standby to GND		273	300	327	k Ω
F_{PWM}	Pulse width modulator base frequency		180	250	320	kHz
SNR	Signal to noise ratio	A-weighting, $P_{out} = 0.6W$, $R_L = 8\Omega$		83		dB
t_{WU}	Wake-uptime			5	10	ms
t_{STBY}	Standby time			5	10	ms

Table 7. $V_{CC} = +3.6V$, $GND = 0V$, $V_{IC} = 2.5V$, $T_{amb} = 25^{\circ}C$ (unless otherwise specified)⁽¹⁾ (continued)

Symbol	Parameter	Conditions	Min.	Typ.	Max.	Unit
V_N	Output voltage noise	F = 20Hz to 20kHz, G = 6dB Unweighted $R_L = 4\Omega$ A-weighted $R_L = 4\Omega$		83 57		μV_{RMS}
		Unweighted $R_L = 8\Omega$ A-weighted $R_L = 8\Omega$		83 61		
		Unweighted $R_L = 4\Omega + 15\mu H$ A-weighted $R_L = 4\Omega + 15\mu H$		81 58		
		Unweighted $R_L = 4\Omega + 30\mu H$ A-weighted $R_L = 4\Omega + 30\mu H$		87 62		
		Unweighted $R_L = 8\Omega + 30\mu H$ A-weighted $R_L = 8\Omega + 30\mu H$		77 56		
		Unweighted $R_L = 4\Omega + \text{Filter}$ A-weighted $R_L = 4\Omega + \text{Filter}$		85 63		
		Unweighted $R_L = 4\Omega + \text{Filter}$ A-weighted $R_L = 4\Omega + \text{Filter}$		80 57		

1. All electrical values are guaranteed with correlation measurements at 2.5V and 5V.
2. Standby mode is active when V_{STBY} is tied to GND.
3. Dynamic measurements - $20 \cdot \log(\text{rms}(V_{out})/\text{rms}(V_{ripple}))$. V_{ripple} is the superimposed sinusoidal signal to V_{CC} @ $F = 217\text{Hz}$.

Table 8. $V_{CC} = +3V$, $GND = 0V$, $V_{IC} = 2.5V$, $T_{amb} = 25^{\circ}C$ (unless otherwise specified)⁽¹⁾

Symbol	Parameter	Conditions	Min.	Typ.	Max.	Unit
I_{CC}	Supply current	No input signal, no load		1.9	2.7	mA
I_{STBY}	Standby current ⁽²⁾	No input signal, $V_{STBY} = GND$		10	1000	nA
V_{OO}	Output offset voltage	No input signal, $R_L = 8\Omega$		3	25	mV
P_{out}	Output power	G=6dB THD = 1% max, F = 1kHz, $R_L = 4\Omega$ THD = 10% max, F = 1kHz, $R_L = 4\Omega$ THD = 1% max, F = 1kHz, $R_L = 8\Omega$ THD = 10% max, F = 1kHz, $R_L = 8\Omega$		0.75 1 0.5 0.6		W
THD + N	Total harmonic distortion + noise	$P_{out} = 350mW_{RMS}$, G = 6dB, 20Hz < F < 20kHz $R_L = 8\Omega + 15\mu H$, BW < 30kHz $P_{out} = 350mW_{RMS}$, G = 6dB, F = 1kHz, $R_L = 8\Omega + 15\mu H$, BW < 30kHz		1 0.21		%
Efficiency	Efficiency	$P_{out} = 0.7W_{RMS}$, $R_L = 4\Omega + \geq 15\mu H$ $P_{out} = 0.45W_{RMS}$, $R_L = 8\Omega + \geq 15\mu H$		78 88		%
PSRR	Power supply rejection ratio with inputs grounded ⁽³⁾	F = 217Hz, $R_L = 8\Omega$, G=6dB, $V_{ripple} = 200mV_{pp}$		60		dB
CMRR	Common mode rejection ratio	F = 217Hz, $R_L = 8\Omega$, G = 6dB, $\Delta V_{icm} = 200mV_{pp}$		54		dB
Gain	Gain value	R_{in} in k Ω	$\frac{273k\Omega}{R_{in}}$	$\frac{300k\Omega}{R_{in}}$	$\frac{327k\Omega}{R_{in}}$	V/V
R_{STBY}	Internal resistance from Standby to GND		273	300	327	k Ω
F_{PWM}	Pulse width modulator base frequency		180	250	320	kHz
SNR	Signal to noise ratio	A-weighting, $P_{out} = 0.4W$, $R_L = 8\Omega$		82		dB
t_{WU}	Wake-up time			5	10	ms
t_{STBY}	Standby time			5	10	ms

Table 8. $V_{CC} = +3V$, $GND = 0V$, $V_{IC} = 2.5V$, $T_{amb} = 25^{\circ}C$ (unless otherwise specified)⁽¹⁾ (continued)

Symbol	Parameter	Conditions	Min.	Typ.	Max.	Unit
V_N	Output voltage noise	$f = 20Hz$ to $20kHz$, $G = 6dB$ Unweighted $R_L = 4\Omega$ A-weighted $R_L = 4\Omega$		83 57		μV_{RMS}
		Unweighted $R_L = 8\Omega$ A-weighted $R_L = 8\Omega$		83 61		
		Unweighted $R_L = 4\Omega + 15\mu H$ A-weighted $R_L = 4\Omega + 15\mu H$		81 58		
		Unweighted $R_L = 4\Omega + 30\mu H$ A-weighted $R_L = 4\Omega + 30\mu H$		87 62		
		Unweighted $R_L = 8\Omega + 30\mu H$ A-weighted $R_L = 8\Omega + 30\mu H$		77 56		
		Unweighted $R_L = 4\Omega + \text{Filter}$ A-weighted $R_L = 4\Omega + \text{Filter}$		85 63		
		Unweighted $R_L = 4\Omega + \text{Filter}$ A-weighted $R_L = 4\Omega + \text{Filter}$		80 57		

1. All electrical values are guaranteed with correlation measurements at 2.5 V and 5 V.
2. Standby mode is active when V_{STBY} is tied to GND.
3. Dynamic measurements - $20 \cdot \log(\text{rms}(V_{out})/\text{rms}(V_{ripple}))$. V_{ripple} is the superimposed sinusoidal signal to V_{CC} @ $F = 217Hz$.

Table 9. $V_{CC} = +2.5V$, $GND = 0V$, $V_{IC} = 2.5V$, $T_{amb} = 25^{\circ}C$ (unless otherwise specified)

Symbol	Parameter	Conditions	Min.	Typ.	Max.	Unit
I_{CC}	Supply current	No input signal, no load		1.7	2.4	mA
I_{STBY}	Standby current ⁽¹⁾	No input signal, $V_{STBY} = GND$		10	1000	nA
V_{OO}	Output offset voltage	No input signal, $R_L = 8\Omega$		3	25	mV
P_{out}	Output power	G=6dB THD = 1% max, F = 1kHz, $R_L = 4\Omega$ THD = 10% max, F = 1kHz, $R_L = 4\Omega$ THD = 1% max, F = 1kHz, $R_L = 8\Omega$ THD = 10% max, F = 1kHz, $R_L = 8\Omega$		0.52 0.71 0.33 0.42		W
THD + N	Total harmonic distortion + noise	$P_{out} = 200mW_{RMS}$, G = 6dB, 20Hz < F < 20kHz $R_L = 8\Omega + 15\mu H$, BW < 30kHz $P_{out} = 200W_{RMS}$, G = 6dB, F = 1kHz, $R_L = 8\Omega + 15\mu H$, BW < 30kHz		1 0.19		%
Efficiency	Efficiency	$P_{out} = 0.47W_{RMS}$, $R_L = 4\Omega + \geq 15\mu H$ $P_{out} = 0.3W_{RMS}$, $R_L = 8\Omega + \geq 15\mu H$		78 88		%
PSRR	Power supply rejection ratio with inputs grounded ⁽²⁾	F = 217Hz, $R_L = 8\Omega$, G=6dB, $V_{ripple} = 200mV_{pp}$		60		dB
CMRR	Common mode rejection ratio	F = 217Hz, $R_L = 8\Omega$, G = 6dB, $\Delta V_{icm} = 200mV_{pp}$		54		dB
Gain	Gain value	R_{in} in k Ω	$\frac{273k\Omega}{R_{in}}$	$\frac{300k\Omega}{R_{in}}$	$\frac{327k\Omega}{R_{in}}$	V/V
R_{STBY}	Internal resistance from Standby to GND		273	300	327	k Ω
F_{PWM}	Pulse width modulator base frequency		180	250	320	kHz
SNR	Signal to noise ratio	A-weighting, $P_{out} = 1.2W$, $R_L = 8\Omega$		80		dB
t_{WU}	Wake-up time			5	10	ms
t_{STBY}	Standby time			5	10	ms

Table 9. $V_{CC} = +2.5V$, $GND = 0V$, $V_{IC} = 2.5V$, $T_{amb} = 25^{\circ}C$ (unless otherwise specified) (continued)

Symbol	Parameter	Conditions	Min.	Typ.	Max.	Unit
V_N	Output voltage noise	F = 20Hz to 20kHz, G = 6dB Unweighted $R_L = 4\Omega$ A-weighted $R_L = 4\Omega$		85 60		μV_{RMS}
		Unweighted $R_L = 8\Omega$ A-weighted $R_L = 8\Omega$		86 62		
		Unweighted $R_L = 4\Omega + 15\mu H$ A-weighted $R_L = 4\Omega + 15\mu H$		76 56		
		Unweighted $R_L = 4\Omega + 30\mu H$ A-weighted $R_L = 4\Omega + 30\mu H$		82 60		
		Unweighted $R_L = 8\Omega + 30\mu H$ A-weighted $R_L = 8\Omega + 30\mu H$		67 53		
		Unweighted $R_L = 4\Omega + \text{Filter}$ A-weighted $R_L = 4\Omega + \text{Filter}$		78 57		
		Unweighted $R_L = 4\Omega + \text{Filter}$ A-weighted $R_L = 4\Omega + \text{Filter}$		74 54		

- Standby mode is active when V_{STBY} is tied to GND.
- Dynamic measurements - $20 \cdot \log(\text{rms}(V_{out})/\text{rms}(V_{ripple}))$. V_{ripple} is the superimposed sinusoidal signal to V_{CC} @ $F = 217\text{Hz}$.

Table 10. $V_{CC} = +2.4V$, $GND = 0V$, $V_{IC} = 2.5V$, $T_{amb} = 25^{\circ}C$ (unless otherwise specified)

Symbol	Parameter	Conditions	Min.	Typ.	Max.	Unit
I_{CC}	Supply current	No input signal, no load		1.7		mA
I_{STBY}	Standby current ⁽¹⁾	No input signal, $V_{STBY} = GND$		10		nA
V_{OO}	Output offset voltage	No input signal, $R_L = 8\Omega$		3		mV
P_{out}	Output power	G=6dB THD = 1% max, F = 1kHz, $R_L = 4\Omega$ THD = 10% max, F = 1kHz, $R_L = 4\Omega$ THD = 1% max, F = 1kHz, $R_L = 8\Omega$ THD = 10% max, F = 1kHz, $R_L = 8\Omega$		0.48 0.65 0.3 0.38		W
THD + N	Total harmonic distortion + noise	$P_{out} = 200mW_{RMS}$, G = 6dB, 20Hz < F < 20kHz $R_L = 8\Omega + 15\mu H$, BW < 30kHz		1		%
Efficiency	Efficiency	$P_{out} = 0.38W_{RMS}$, $R_L = 4\Omega + \geq 15\mu H$ $P_{out} = 0.25W_{RMS}$, $R_L = 8\Omega + \geq 15\mu H$		77 86		%
CMRR	Common mode rejection ratio	F = 217Hz, $R_L = 8\Omega$, G = 6dB, $DV_{icm} = 200mV_{pp}$		54		dB
Gain	Gain value	R_{in} in $k\Omega$	$\frac{273k\Omega}{R_{in}}$	$\frac{300k\Omega}{R_{in}}$	$\frac{327k\Omega}{R_{in}}$	V/V
R_{STBY}	Internal resistance from Standby to GND		273	300	327	$k\Omega$
F_{PWM}	Pulse width modulator base frequency			250		kHz
SNR	Signal to noise ratio	A Weighting, $P_{out} = 1.2W$, $R_L = 8\Omega$		80		dB
t_{WU}	Wake-up time			5		ms
t_{STBY}	Standby time			5		ms
V_N	Output voltage noise	F = 20Hz to 20kHz, G = 6dB Unweighted $R_L = 4\Omega$ A-weighted $R_L = 4\Omega$ Unweighted $R_L = 8\Omega$ A-weighted $R_L = 8\Omega$ Unweighted $R_L = 4\Omega + 15\mu H$ A-weighted $R_L = 4\Omega + 15\mu H$ Unweighted $R_L = 4\Omega + 30\mu H$ A-weighted $R_L = 4\Omega + 30\mu H$ Unweighted $R_L = 8\Omega + 30\mu H$ A-weighted $R_L = 8\Omega + 30\mu H$ Unweighted $R_L = 4\Omega + \text{Filter}$ A-weighted $R_L = 4\Omega + \text{Filter}$ Unweighted $R_L = 4\Omega + \text{Filter}$ A-weighted $R_L = 4\Omega + \text{Filter}$		85 60 86 62 76 56 82 60 67 53 78 57 74 54		μV_{RMS}

1. Standby mode is active when V_{STBY} is tied to GND.

4 Electrical characteristic curves

The graphs included in this section use the following abbreviations:

- $R_L + 15 \mu\text{H}$ or $30 \mu\text{H}$ = pure resistor + very low series resistance inductor
- Filter = LC output filter ($1 \mu\text{F} + 30 \mu\text{H}$ for 4Ω and $0.5 \mu\text{F} + 60 \mu\text{H}$ for 8Ω)
- All measurements done with $C_{s1} = 1 \mu\text{F}$ and $C_{s2} = 100 \text{ nF}$ except for PSRR where C_{s1} is removed.

Figure 2. Test diagram for measurements

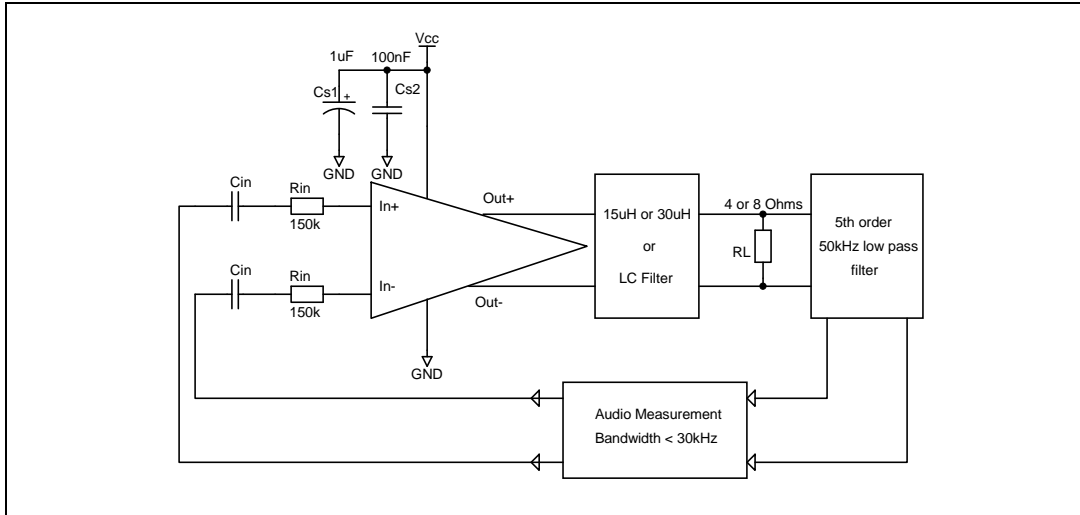

Figure 3. Test diagram for PSRR measurements

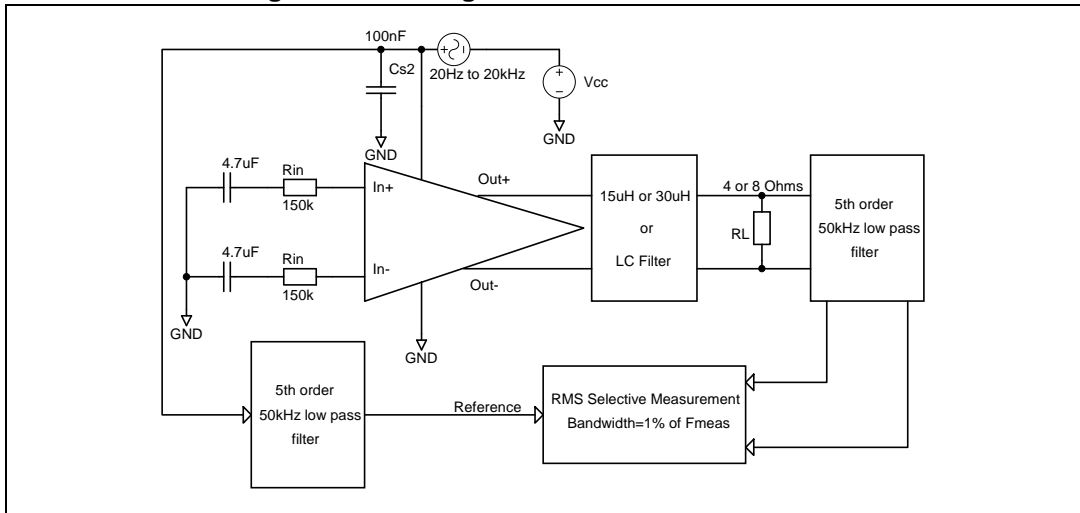

Figure 4. Current consumption vs. power supply voltage

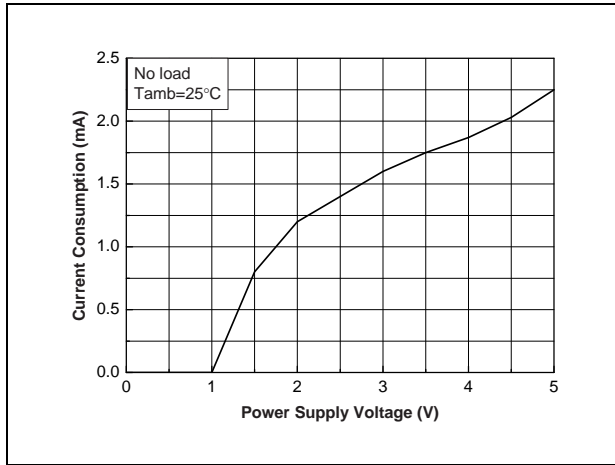

Figure 5. Current consumption vs. standby voltage

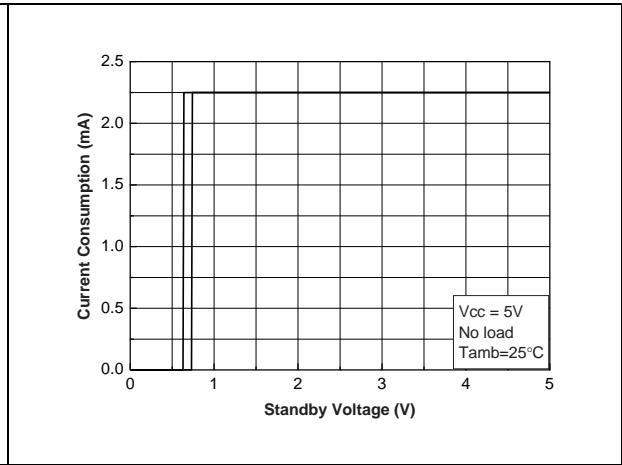

Figure 6. Current consumption vs. standby voltage

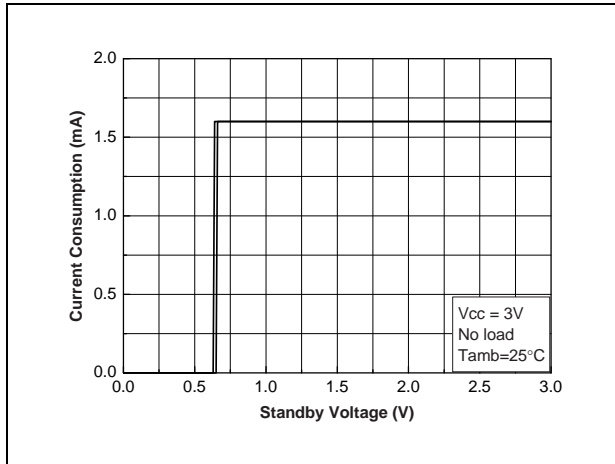

Figure 7. Output offset voltage vs. common mode input voltage

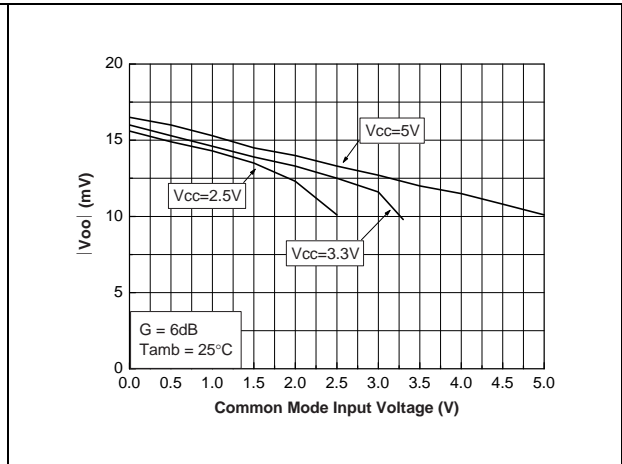

Figure 8. Efficiency vs. output power

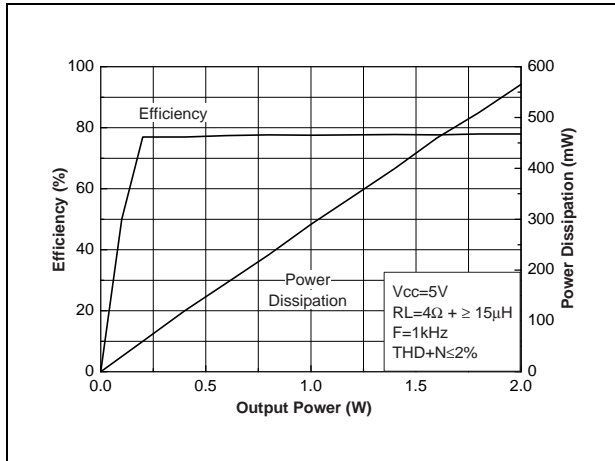

Figure 9. Efficiency vs. output power

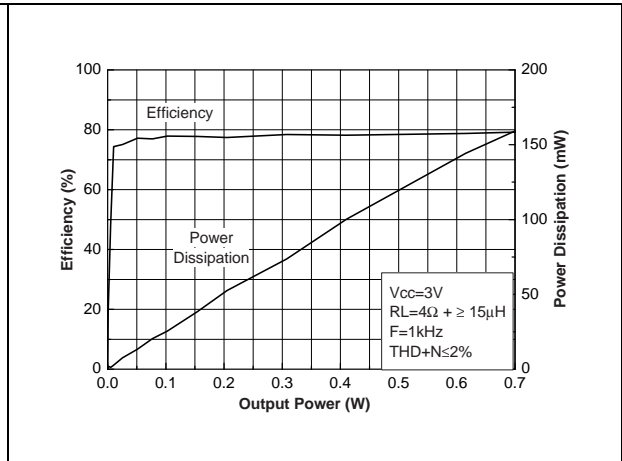

Figure 10. Efficiency vs. output power

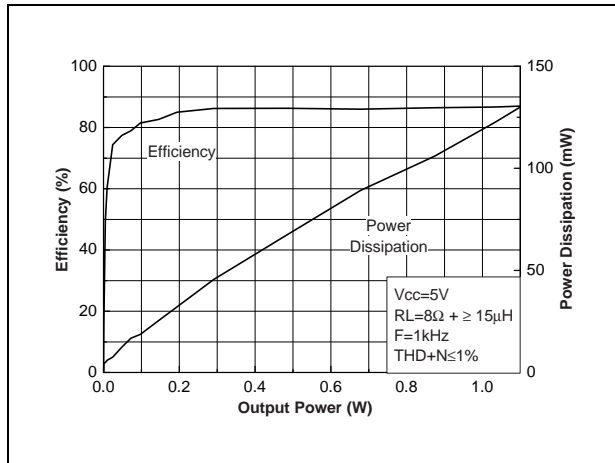

Figure 11. Efficiency vs. output power

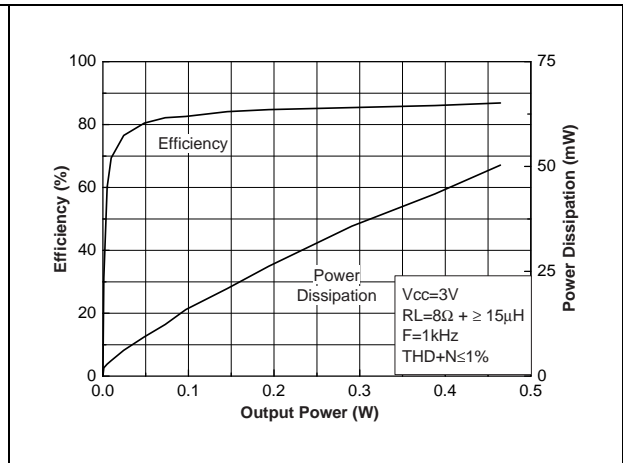

Figure 12. Output power vs. power supply voltage

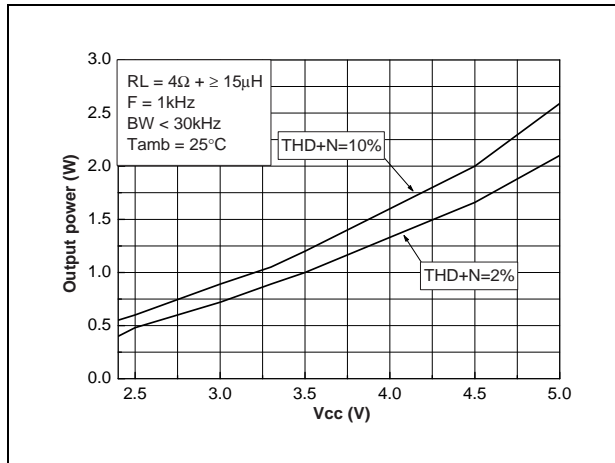

Figure 13. Output power vs. power supply voltage

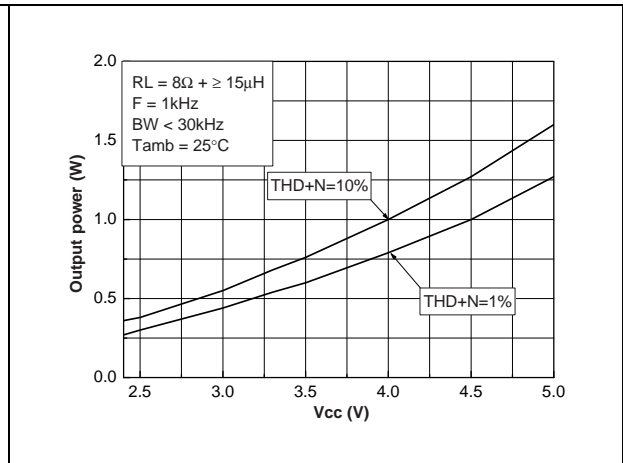

Figure 14. PSRR vs. frequency

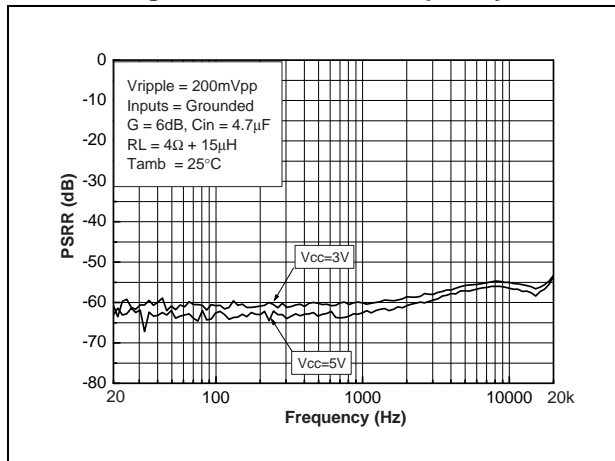

Figure 15. PSRR vs. frequency

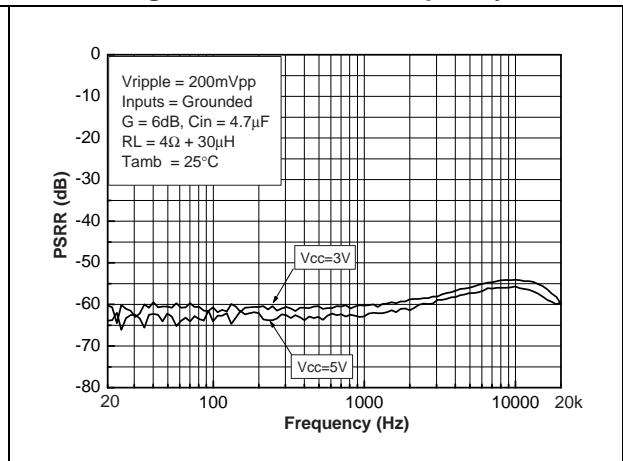

Figure 16. PSRR vs. frequency

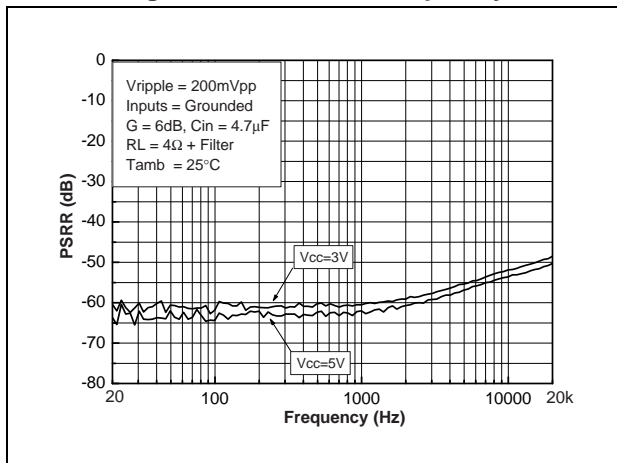

Figure 17. PSRR vs. frequency

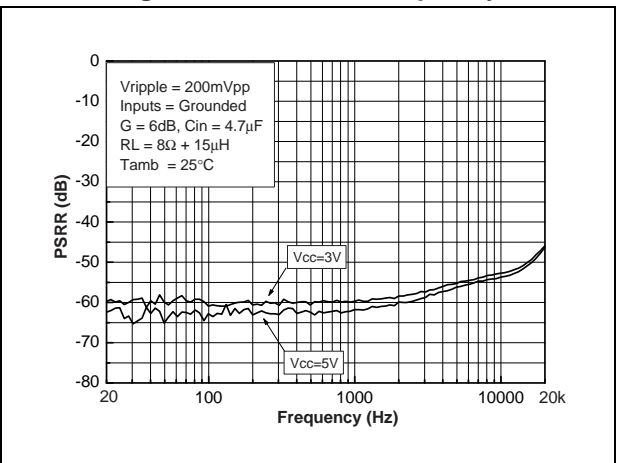

Figure 18. PSRR vs. frequency

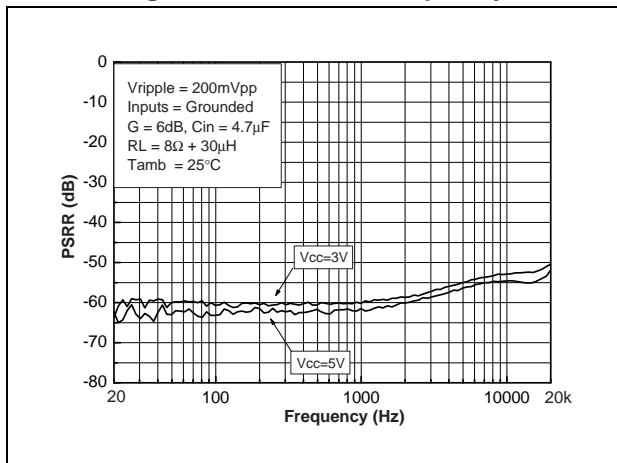

Figure 19. PSRR vs. frequency

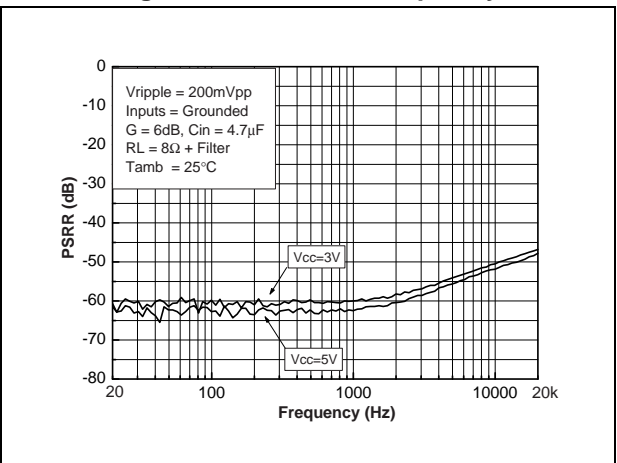

Figure 20. PSRR vs. common mode input voltage

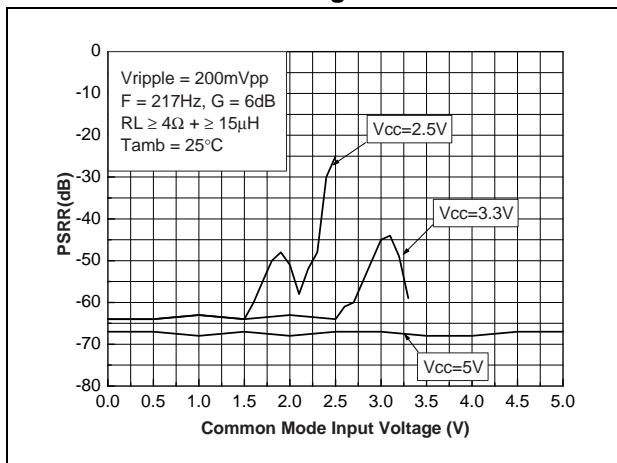

Figure 21. CMRR vs. frequency

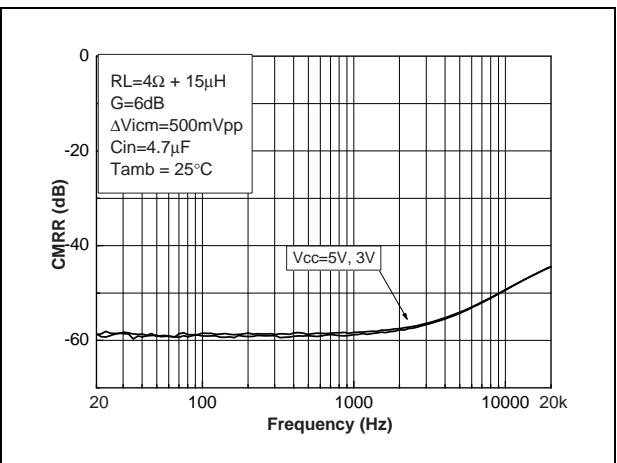

Figure 22. CMRR vs. frequency

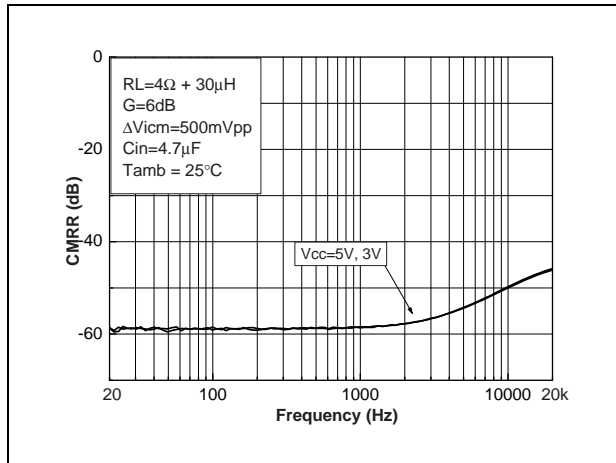

Figure 23. CMRR vs. frequency

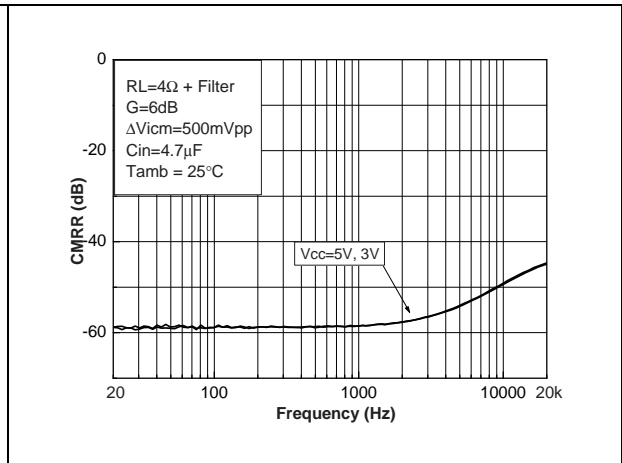

Figure 24. CMRR vs. frequency

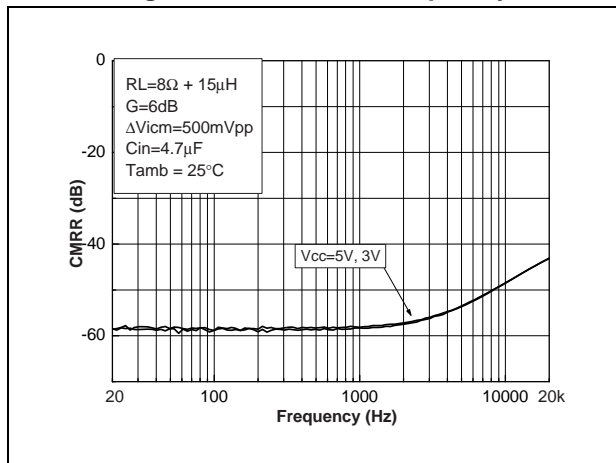

Figure 25. CMRR vs. frequency

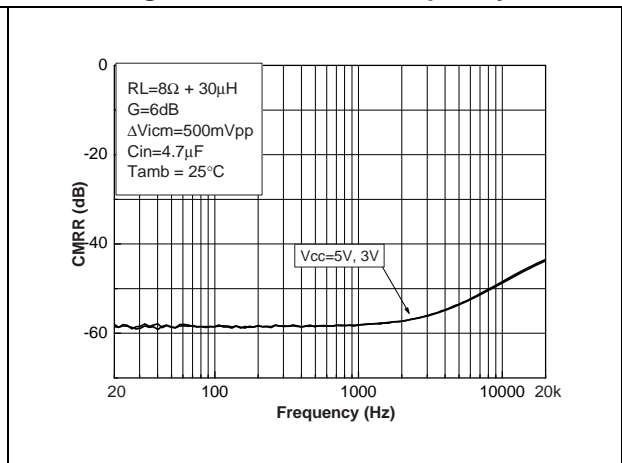

Figure 26. CMRR vs. frequency

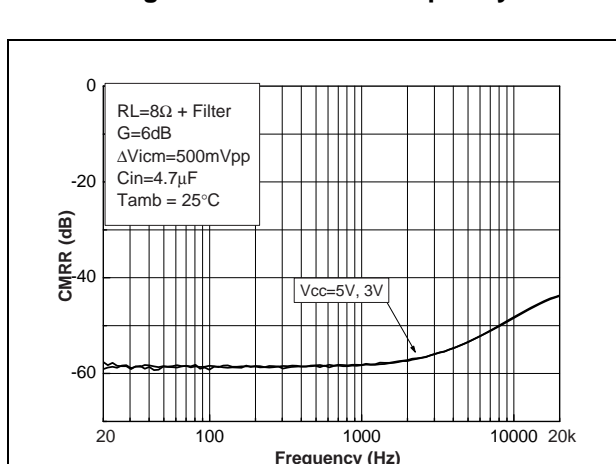

Figure 27. CMRR vs. common mode input voltage

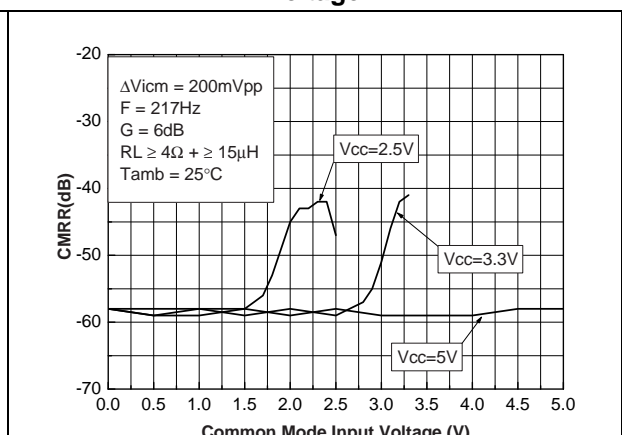

Figure 28. THD+N vs. output power

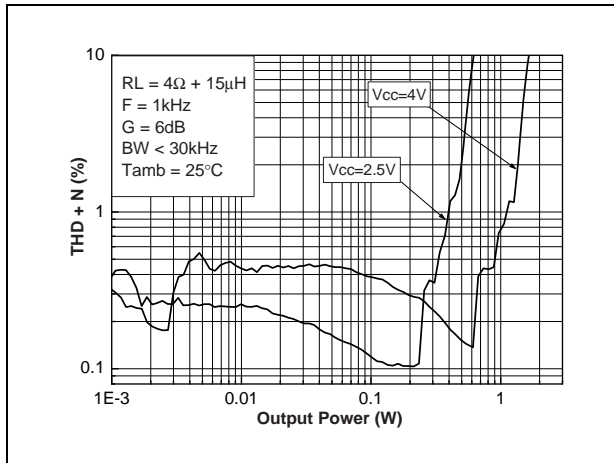

Figure 29. THD+N vs. output power

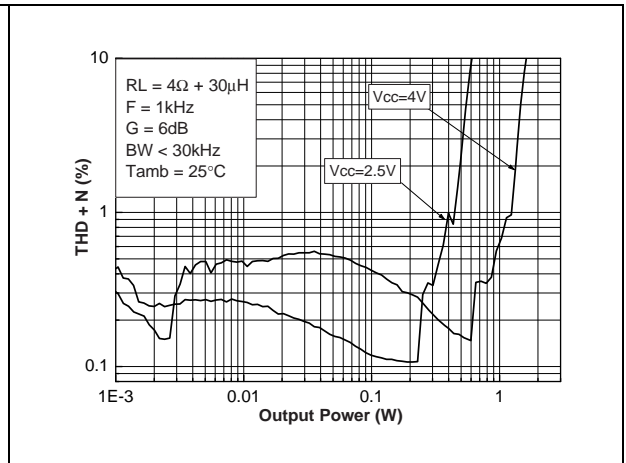

Figure 30. THD+N vs. output power

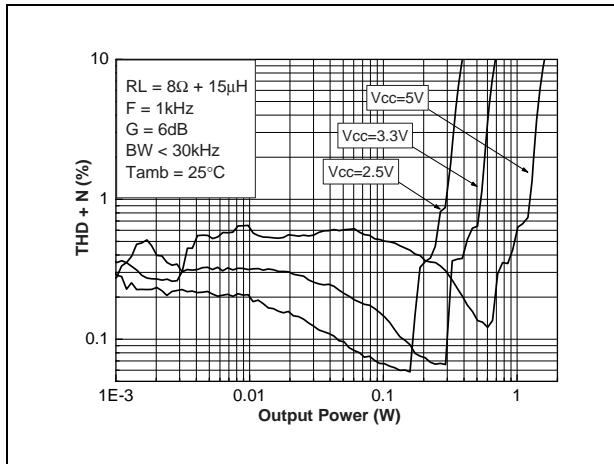

Figure 31. THD+N vs. output power

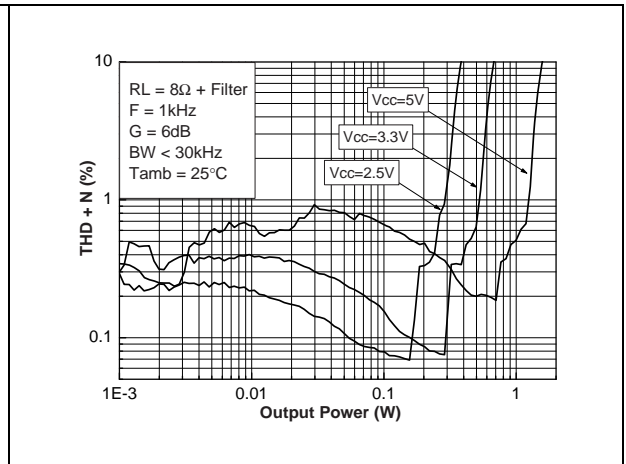

Figure 32. THD+N vs. output power

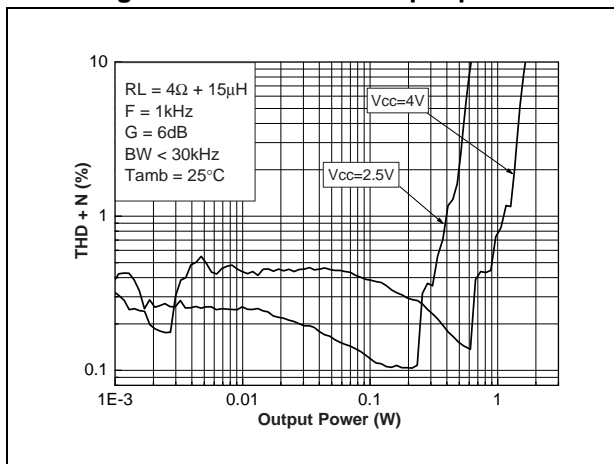

Figure 33. THD+N vs. output power

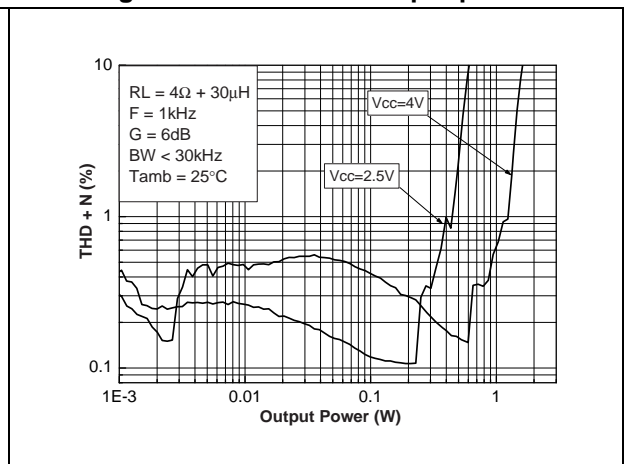

Figure 34. THD+N vs. output power

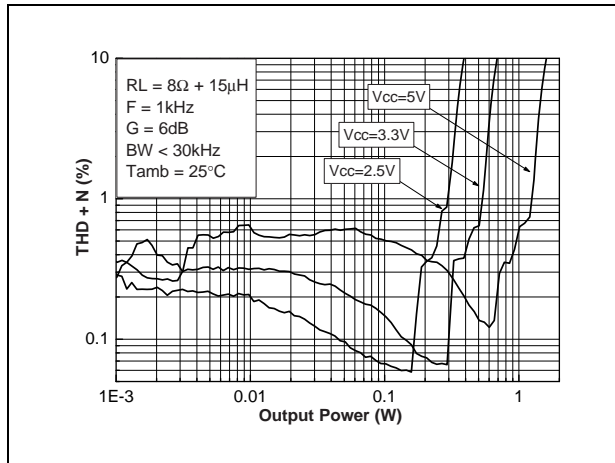

Figure 35. THD+N vs. output power

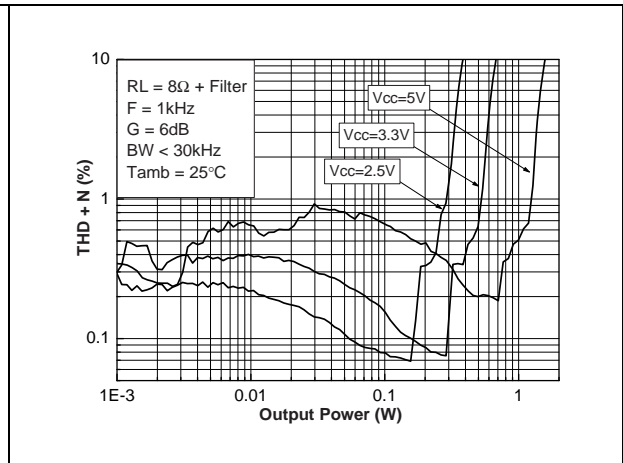

Figure 36. THD+N vs. frequency

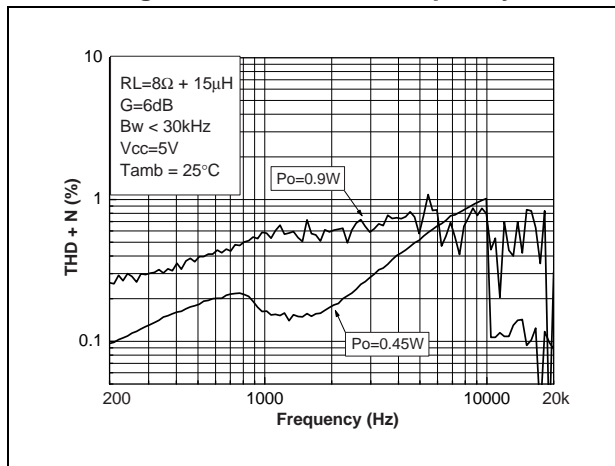

Figure 37. THD+N vs. frequency

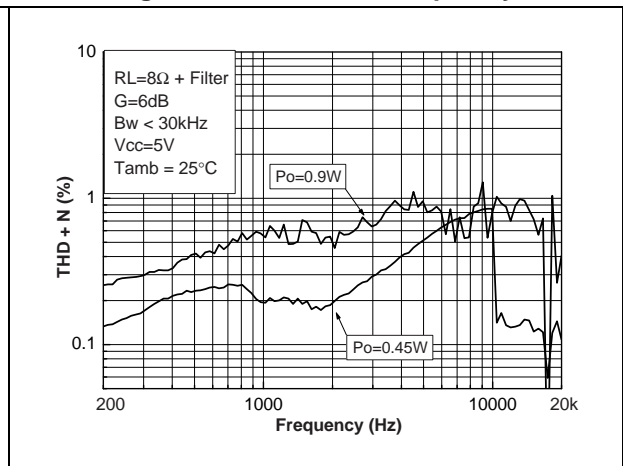

Figure 38. THD+N vs. frequency

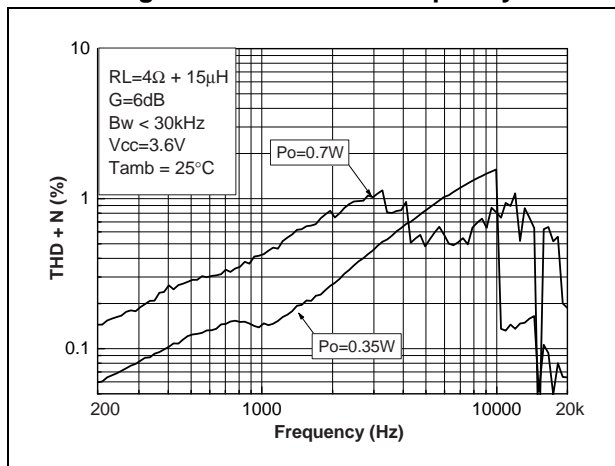

Figure 39. THD+N vs. frequency

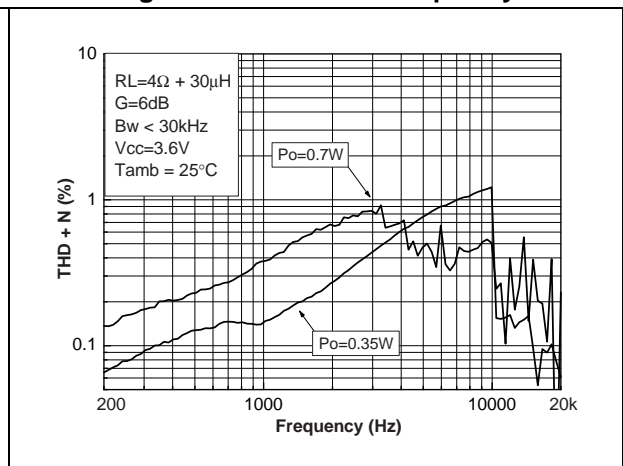

Figure 40. THD+N vs. frequency

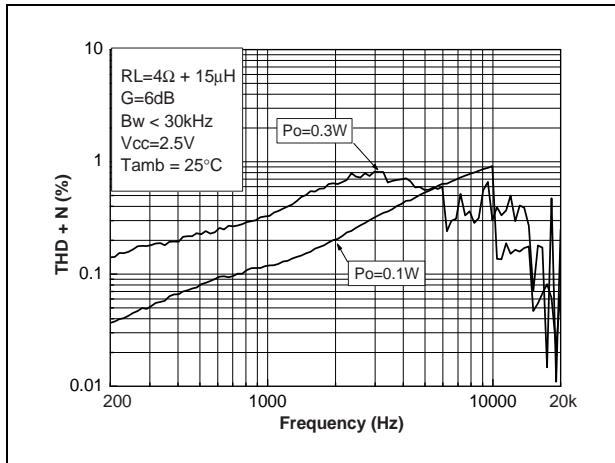

Figure 41. THD+N vs. frequency

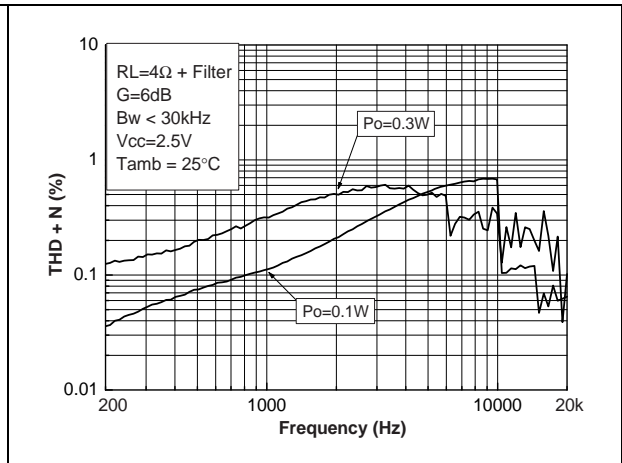

Figure 42. THD+N vs. frequency

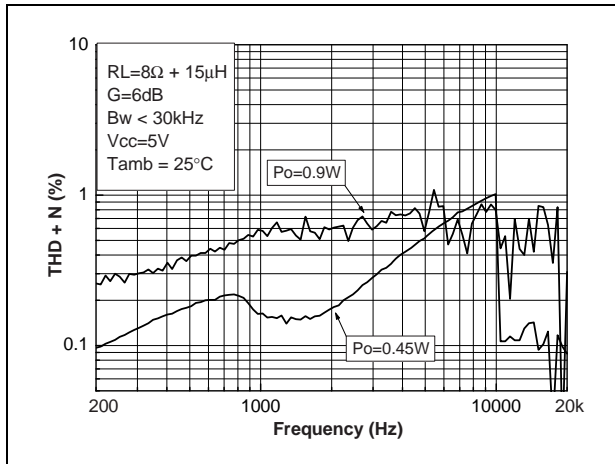

Figure 43. THD+N vs. frequency

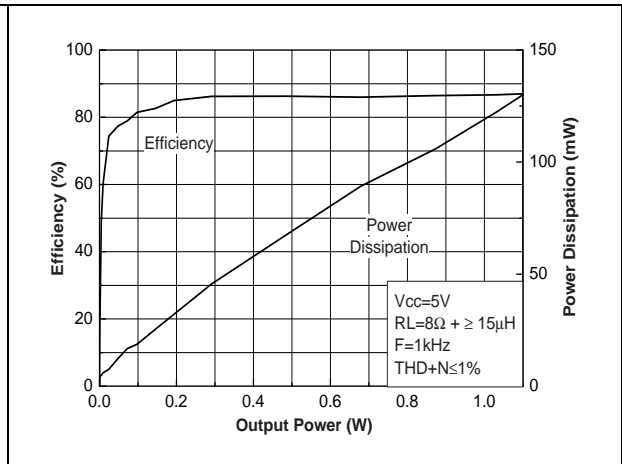

Figure 44. THD+N vs. frequency

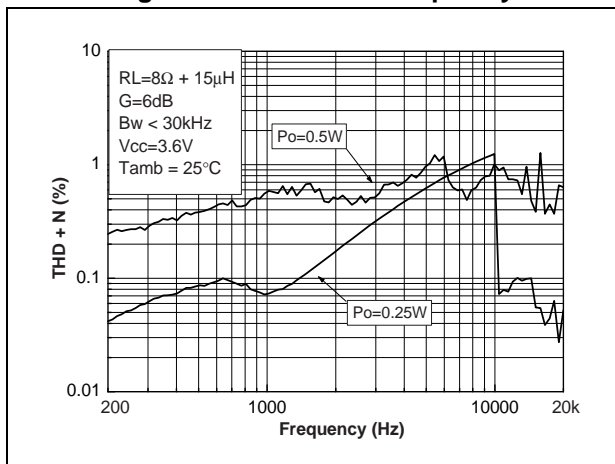

Figure 45. THD+N vs. frequency

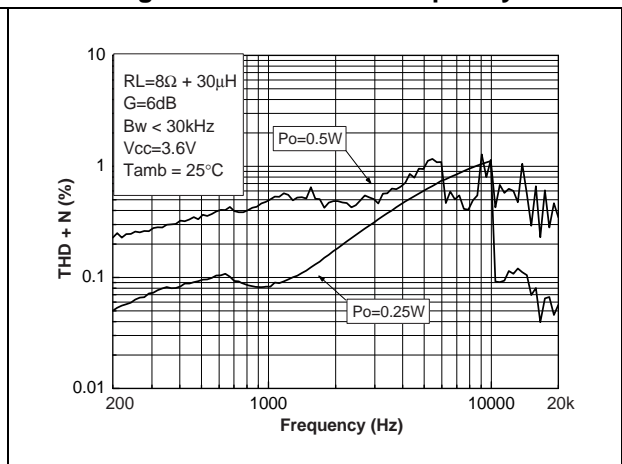

Figure 46. THD+N vs. frequency

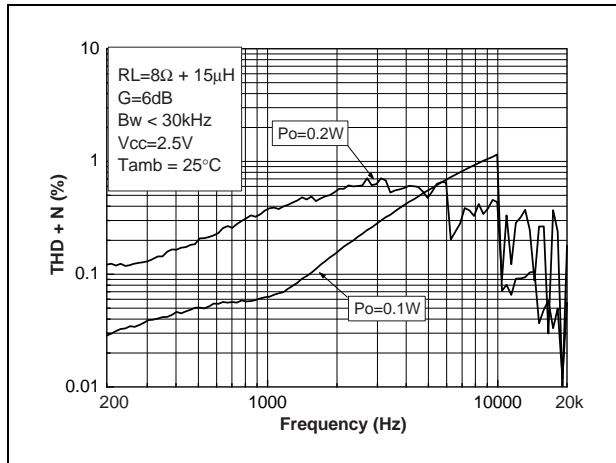

Figure 47. THD+N vs. frequency

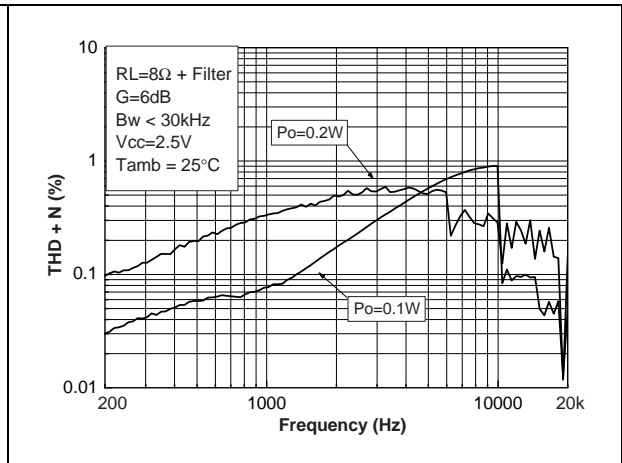

Figure 48. Gain vs. frequency

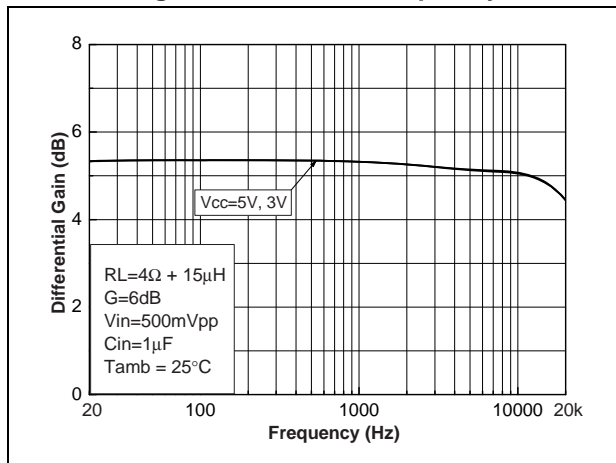

Figure 49. Gain vs. frequency

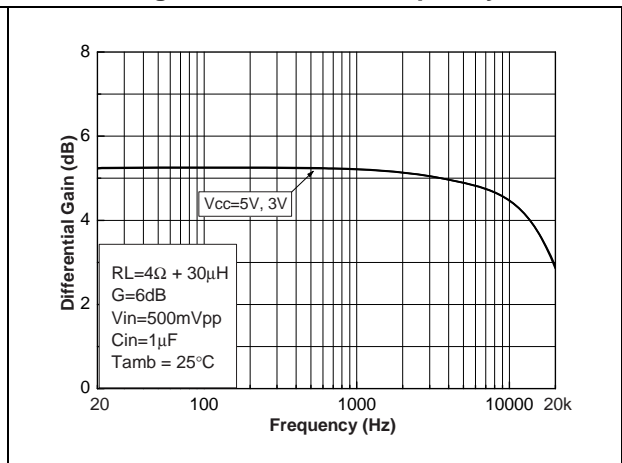

Figure 50. Gain vs. frequency

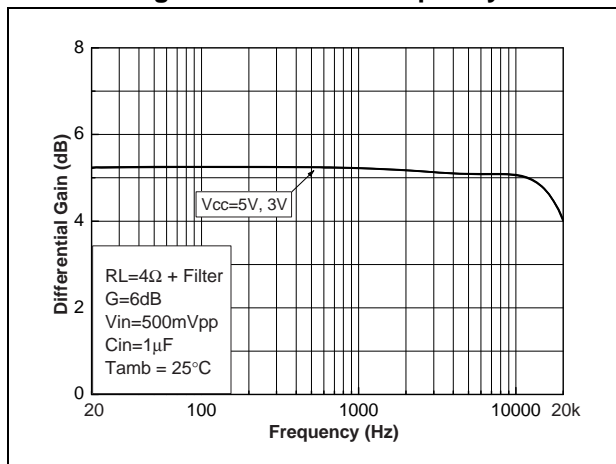

Figure 51. Gain vs. frequency

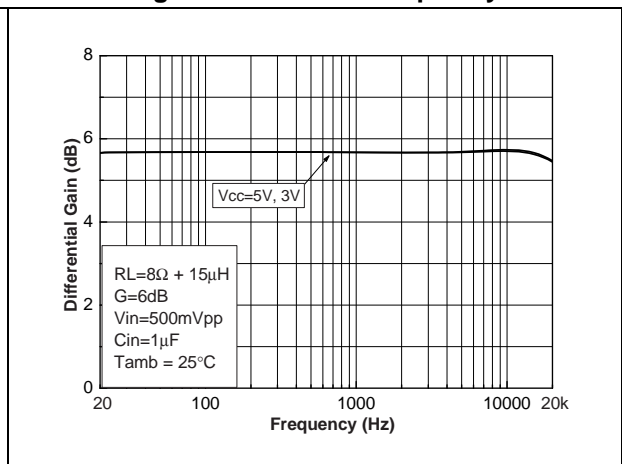

Figure 52. Gain vs. frequency

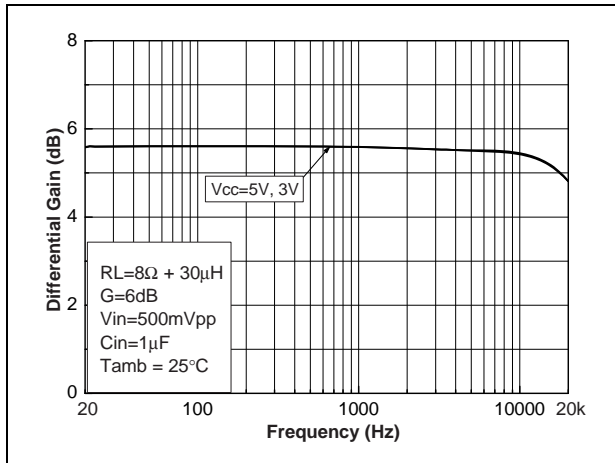

Figure 53. Gain vs. frequency

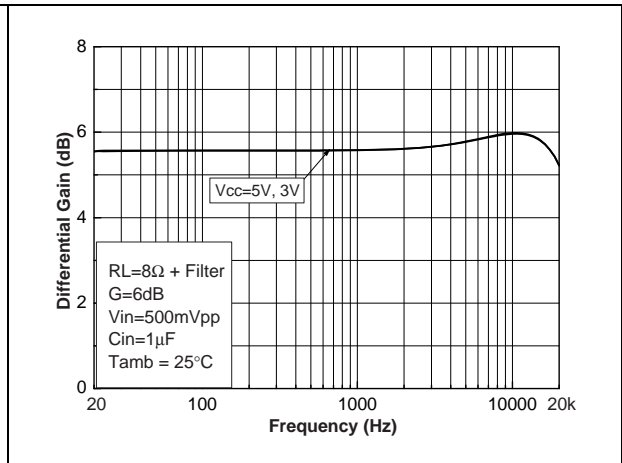

Figure 54. Gain vs. frequency

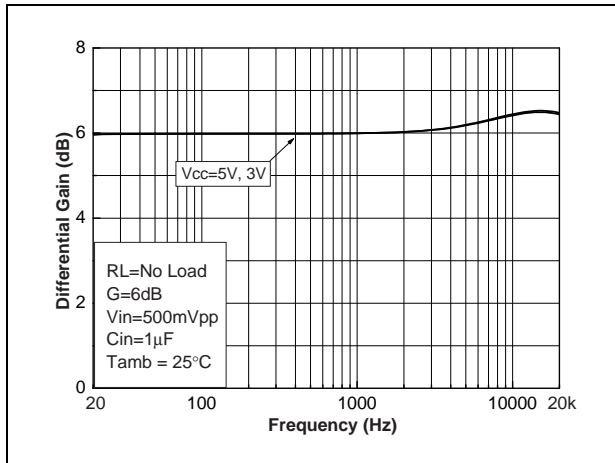

Figure 55. Startup & shutdown time $V_{CC} = 5V$, $G = 6\text{ dB}$, $C_{in} = 1\ \mu\text{F}$ (5 ms/div)

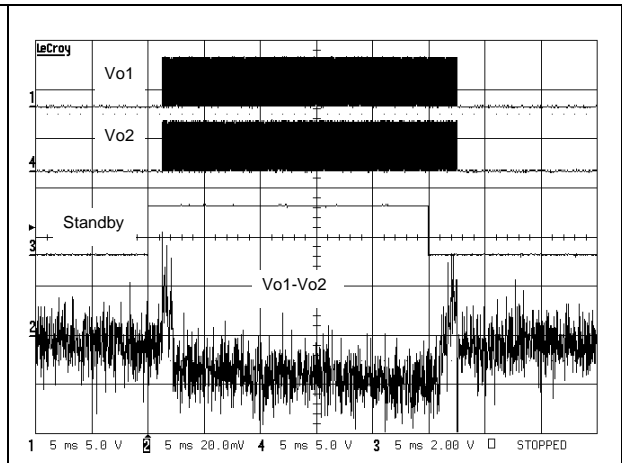

Figure 56. Startup & shutdown time $V_{CC} = 3V$, $G = 6\text{ dB}$, $C_{in} = 1\ \mu\text{F}$ (5 ms/div)

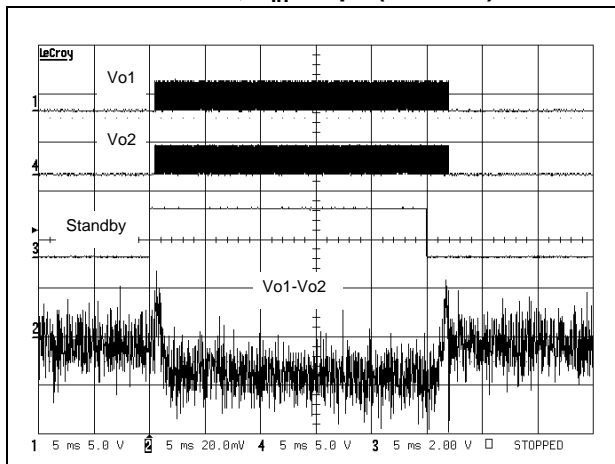

Figure 57. Startup & shutdown time $V_{CC} = 5V$, $G = 6\text{ dB}$, $C_{in} = 100\text{ nF}$ (5 ms/div)

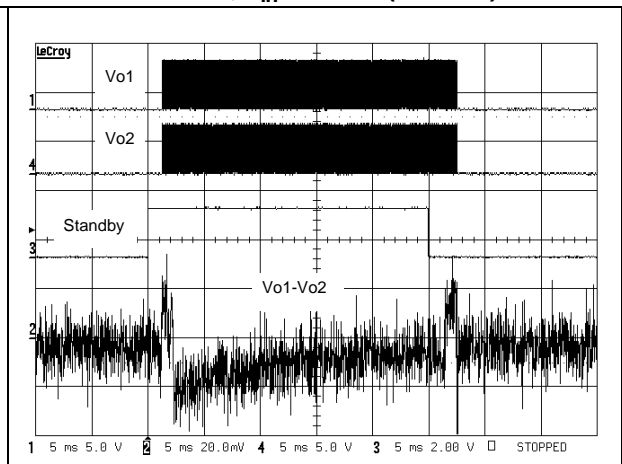

Figure 58. Startup & shutdown time $V_{CC} = 3\text{ V}$, $G = 6\text{ dB}$, $C_{in} = 100\text{ nF}$ (5 ms/div)

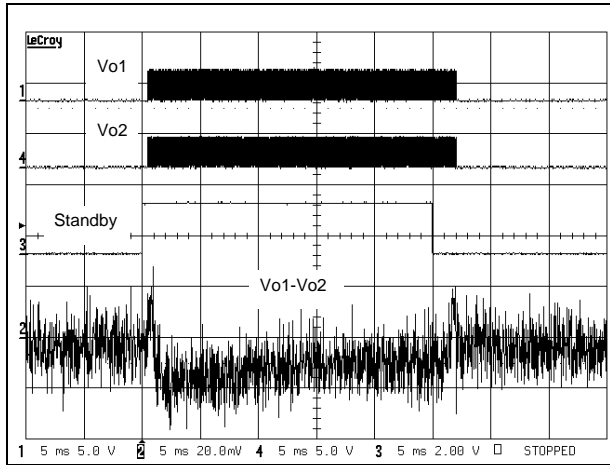

Figure 59. Startup & shutdown time $V_{CC} = 5\text{ V}$, $G = 6\text{ dB}$, No C_{in} (5 ms/div)

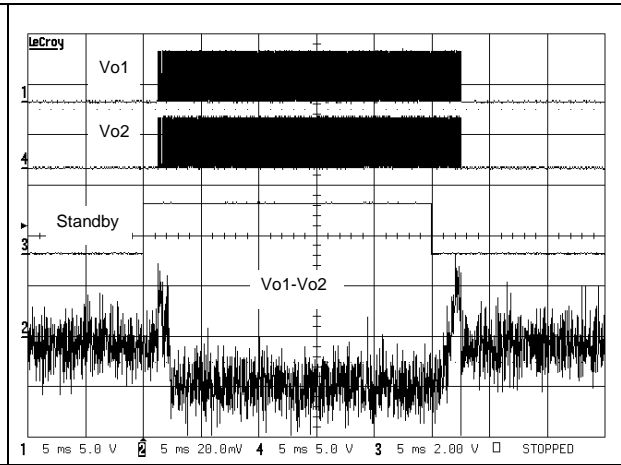
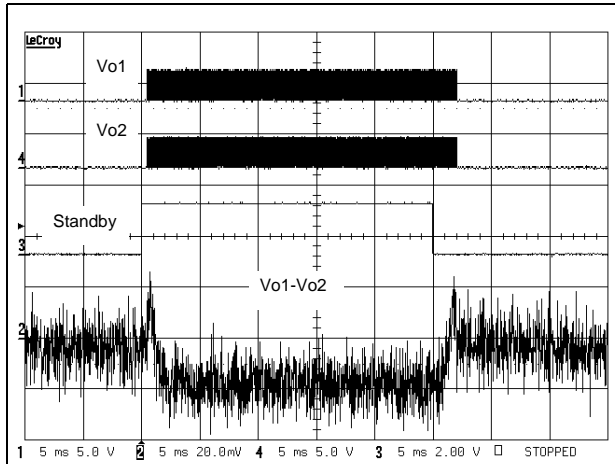

Figure 60. Startup & shutdown time $V_{CC} = 3\text{ V}$, $G = 6\text{ dB}$, No C_{in} (5 ms/div)



5 Application information

5.1 Differential configuration principle

The A21SP16 is a monolithic fully-differential input/output class D power amplifier. The A21SP16 also includes a common-mode feedback loop that controls the output bias value to average it at $V_{CC}/2$ for any DC common mode input voltage. This allows the device to always have a maximum output voltage swing, and by consequence, maximizes the output power. Moreover, as the load is connected differentially compared to a single-ended topology, the output is four times higher for the same power supply voltage.

The advantages of a full-differential amplifier are:

- High PSRR (power supply rejection ratio).
- High common mode noise rejection.
- Virtually zero pop without additional circuitry, giving a faster start-up time compared to conventional single-ended input amplifiers.
- Easier interfacing with differential output audio DAC.
- No input coupling capacitors required due to common mode feedback loop.

The main disadvantage is:

- As the differential function is directly linked to external resistor mismatching, paying particular attention to this mismatching is mandatory in order to obtain the best performance from the amplifier.

5.2 Gain in typical application schematic

Typical differential applications are shown in [Figure 1 on page 4](#).

In the flat region of the frequency-response curve (no input coupling capacitor effect), the differential gain is expressed by the relation:

$$A_{V_{diff}} = \frac{Out^+ - Out^-}{In^+ - In^-} = \frac{300}{R_{in}}$$

with R_{in} expressed in $k\Omega$.

Due to the tolerance of the internal 150 $k\Omega$ feedback resistor, the differential gain will be in the range (no tolerance on R_{in}):

$$\frac{273}{R_{in}} \leq A_{V_{diff}} \leq \frac{327}{R_{in}}$$

5.3 Common mode feedback loop limitations

As explained previously, the common mode feedback loop allows the output DC bias voltage to be averaged at $V_{CC}/2$ for any DC common mode bias input voltage.

However, due to V_{icm} limitation in the input stage (see [Table 3: Operating conditions on page 3](#)), the common mode feedback loop can ensure its role only within a defined range. This range depends upon the values of V_{CC} and R_{in} (A_{Vdiff}). To have a good estimation of the V_{icm} value, we can apply this formula (no tolerance on R_{in}):

$$V_{icm} = \frac{V_{CC} \times R_{in} + 2 \times V_{IC} \times 150k\Omega}{2 \times (R_{in} + 150k\Omega)} \quad (V)$$

with

$$V_{IC} = \frac{In^+ + In^-}{2} \quad (V)$$

and the result of the calculation must be in the range:

$$0.5V \leq V_{icm} \leq V_{CC} - 0.8V$$

Due to the +/-9% tolerance on the 150k Ω resistor, it's also important to check V_{icm} in these conditions:

$$\frac{V_{CC} \times R_{in} + 2 \times V_{IC} \times 136.5k\Omega}{2 \times (R_{in} + 136.5k\Omega)} \leq V_{icm} \leq \frac{V_{CC} \times R_{in} + 2 \times V_{IC} \times 163.5k\Omega}{2 \times (R_{in} + 163.5k\Omega)}$$

If the result of V_{icm} calculation is not in the previous range, input coupling capacitors must be used (with V_{CC} from 2.4 V to 2.5 V, input coupling capacitors are mandatory).

For example:

With $V_{CC} = 3$ V, $R_{in} = 150$ k Ω and $V_{IC} = 2.5$ V, we typically find $V_{icm} = 2$ V and this is lower than $3V - 0.8 V = 2.2$ V. With 136.5 k Ω we find 1.97 V, and with 163.5 k Ω we have 2.02 V. So, no input coupling capacitors are required.

5.4 Low frequency response

If a low frequency bandwidth limitation is requested, it is possible to use input coupling capacitors.

In the low frequency region, C_{in} (input coupling capacitor) starts to have an effect. C_{in} forms, with R_{in} , a first order high-pass filter with a -3dB cut-off frequency:

$$F_{CL} = \frac{1}{2\pi \times R_{in} \times C_{in}} \quad (Hz)$$

So, for a desired cut-off frequency we can calculate C_{in} ,

$$C_{in} = \frac{1}{2\pi \times R_{in} \times F_{CL}} \quad (F)$$

with R_{in} in Ω and F_{CL} in Hz.

5.5 Decoupling of the circuit

A power supply capacitor, referred to as C_S , is needed to correctly bypass the A21SP16.

The A21SP16 has a typical switching frequency at 250 kHz and output fall and rise time about 5 ns. Due to these very fast transients, careful decoupling is mandatory.

A 1 μ F ceramic capacitor is enough, but it must be located very close to the A21SP16 in order to avoid any extra parasitic inductance created an overly long track wire. In relation with dI/dt , this parasitic inductance introduces an overvoltage that decreases the global efficiency and, if it is too high, may cause a breakdown of the device.

In addition, even if a ceramic capacitor has an adequate high frequency ESR value, its current capability is also important. A 0603 size is a good compromise, particularly when a 4 Ω load is used.

Another important parameter is the rated voltage of the capacitor. A 1 μ F/6.3 V capacitor used at 5 V, loses about 50% of its value. In fact, with a 5 V power supply voltage, the decoupling value is about 0.5 μ F instead of 1 μ F. As C_S has particular influence on the THD+N in the medium-high frequency region, this capacitor variation becomes decisive. In addition, less decoupling means higher overshoots, which can be problematic if they reach the power supply AMR value (6 V).

5.6 Wake-up time (t_{WU})

When the standby is released to set the device ON, there is a wait of about 5 ms. The A21SP16 has an internal digital delay that mutes the outputs and releases them after this time in order to avoid any pop noise.

5.7 Shutdown time (t_{STBY})

When the standby command is set, the time required to put the two output stages into high impedance and to put the internal circuitry in shutdown mode, is about 5 ms. This time is used to decrease the gain and avoid any pop noise during shutdown.

5.8 Consumption in shutdown mode

Between the shutdown pin and GND there is an internal 300 k Ω resistor. This resistor forces the A21SP16 to be in standby mode when the standby input pin is left floating.

However, this resistor also introduces additional power consumption if the shutdown pin voltage is not 0 V.

For example, with a 0.4 V standby voltage pin, [Table 3: Operating conditions on page 3](#), shows that you must add $0.4 \text{ V}/300 \text{ k}\Omega = 1.3 \text{ }\mu\text{A}$ in typical ($0.4 \text{ V}/273 \text{ k}\Omega = 1.46 \text{ }\mu\text{A}$ in maximum) to the shutdown current specified in [Table 5 on page 5](#).

5.9 Single-ended input configuration

It is possible to use the A21SP16 in a single-ended input configuration. However, input coupling capacitors are needed in this configuration. The schematic in [Figure 61](#) shows a single-ended input typical application.

Figure 61. Single-ended input typical application

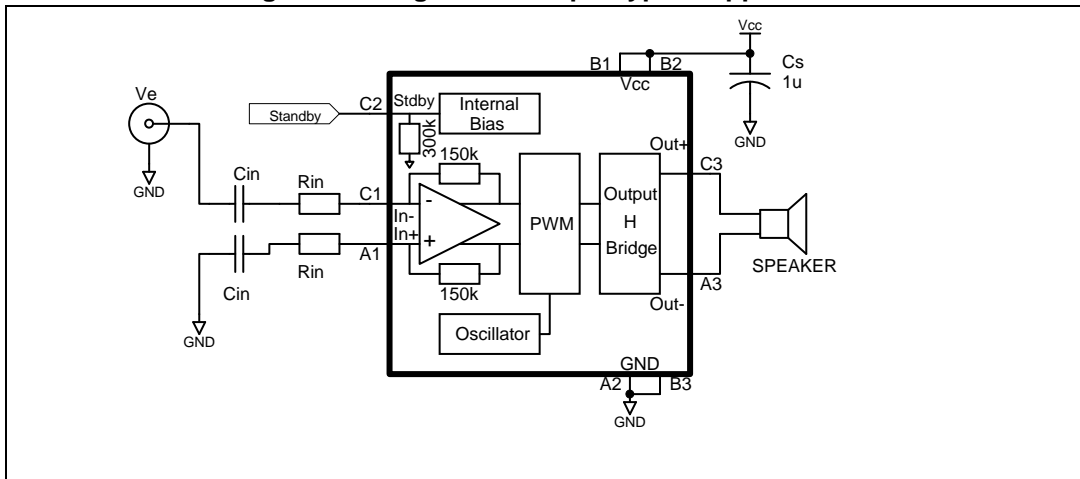

All formulas are identical except for the gain (with R_{in} in $k\Omega$):

$$A_{V_{single}} = \frac{V_e}{Out^+ - Out^-} = \frac{300}{R_{in}}$$

And, due to the internal resistor tolerance we have:

$$\frac{273}{R_{in}} \leq A_{V_{single}} \leq \frac{327}{R_{in}}$$

In the event that multiple single-ended inputs are summed, it is important that the impedance on both A21SP16 inputs (In^- and In^+) are equal.

Figure 62. Typical application schematic with multiple single-ended inputs

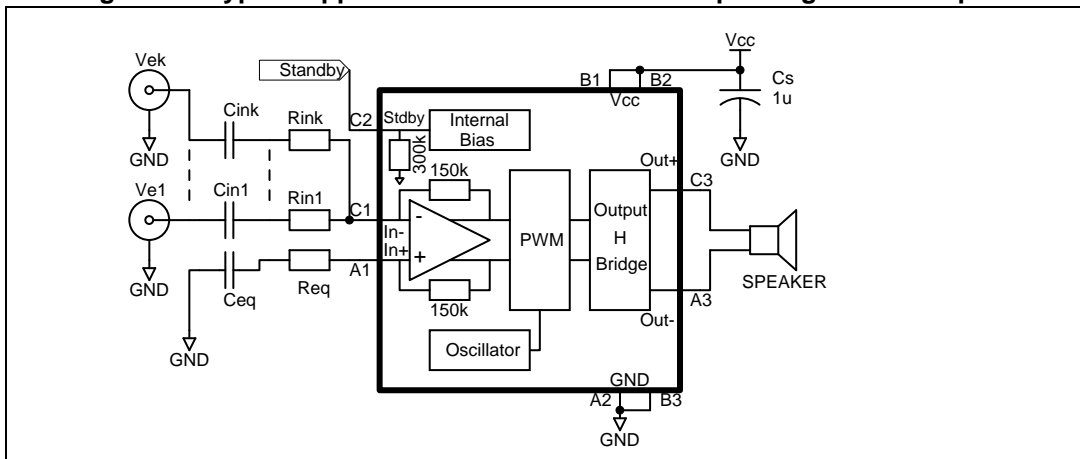

We have the following equations:

$$\text{Out}^+ - \text{Out}^- = V_{e1} \times \frac{300}{R_{in1}} + \dots + V_{ek} \times \frac{300}{R_{ink}} \quad (V)$$

$$C_{eq} = \sum_{j=1}^k C_{inj}$$

$$C_{inj} = \frac{1}{2 \times \pi \times R_{inj} \times F_{CLj}} \quad (F)$$

$$R_{eq} = \frac{1}{\sum_{j=1}^k \frac{1}{R_{inj}}}$$

In general, for mixed situations (single-ended and differential inputs), it is best to use the same rule, that is, to equalize impedance on both A21SP16 inputs.

5.10 Output filter considerations

The A21SP16 is designed to operate without an output filter. However, due to very sharp transients on the A21SP16 output, EMI radiated emissions may cause some standard compliance issues.

These EMI standard compliance issues can appear if the distance between the A21SP16 outputs and loudspeaker terminal is long (typically more than 50 mm, or 100 mm in both directions, to the speaker terminals). As the PCB layout and internal equipment device are different for each configuration, it is difficult to provide a one-size-fits-all solution.

However, to decrease the probability of EMI issues, there are several simple rules to follow:

- Reduce, as much as possible, the distance between the A21SP16 output pins and the speaker terminals.
- Use ground planes for “shielding” sensitive wires.
- Place, as close as possible to the A21SP16 and in series with each output, a ferrite bead with a rated current at minimum 2 A and impedance greater than 50 Ω at frequencies above 30 MHz. If, after testing, these ferrite beads are not necessary, replace them by a short-circuit. Murata BLM18EG221SN1 or BLM18EG121SN1 are possible examples of devices you can use.
- Allow enough footprint to place, if necessary, a capacitor to short perturbations to ground (see the schematics in [Figure 63](#)).

Figure 63. Method for shorting perturbations to ground

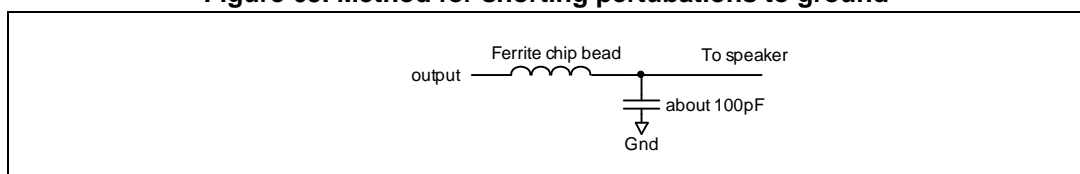

In the case where the distance between the A21SP16 outputs and speaker terminals is high, it is possible to have low frequency EMI issues due to the fact that the typical operating frequency is 250 kHz. In this configuration, we recommend using an output filter (as shown

in [Figure 1: Typical application schematics on page 4](#)). It should be placed as close as possible to the device.

5.11 Different examples with summed inputs

Example 1: Dual differential inputs

Figure 64. Typical application schematic with dual differential inputs

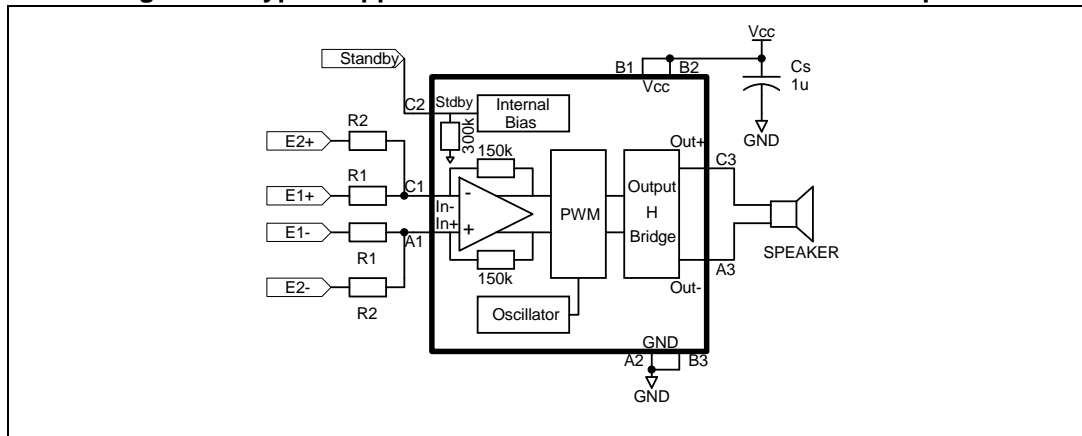

With (R_i in $k\Omega$):

$$A_{V_1} = \frac{Out^+ - Out^-}{E_1^+ - E_1^-} = \frac{300}{R_1}$$

$$A_{V_2} = \frac{Out^+ - Out^-}{E_2^+ - E_2^-} = \frac{300}{R_2}$$

$$0.5V \leq \frac{V_{CC} \times R_1 \times R_2 + 300 \times (V_{IC1} \times R_2 + V_{IC2} \times R_1)}{300 \times (R_1 + R_2) + 2 \times R_1 \times R_2} \leq V_{CC} - 0.8V$$

$$V_{IC1} = \frac{E_1^+ + E_1^-}{2} \quad \text{and} \quad V_{IC2} = \frac{E_2^+ + E_2^-}{2}$$

Example 2: One differential input plus one single-ended input

Figure 65. Typical application schematic with one differential input plus one single-ended input

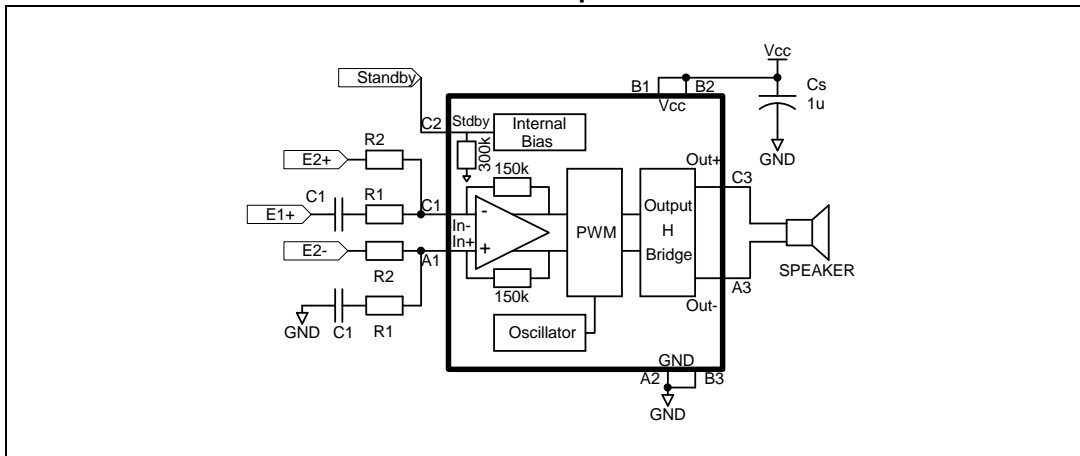

With (R_i in kΩ):

$$A_{V_1} = \frac{Out^+ - Out^-}{E_1^+} = \frac{300}{R_1}$$

$$A_{V_2} = \frac{Out^+ - Out^-}{E_2^+ - E_2^-} = \frac{300}{R_2}$$

$$C_1 = \frac{1}{2\pi \times R_1 \times F_{CL}} \quad (F)$$

6 Footprint recommendations

Figure 66. Footprint recommendations

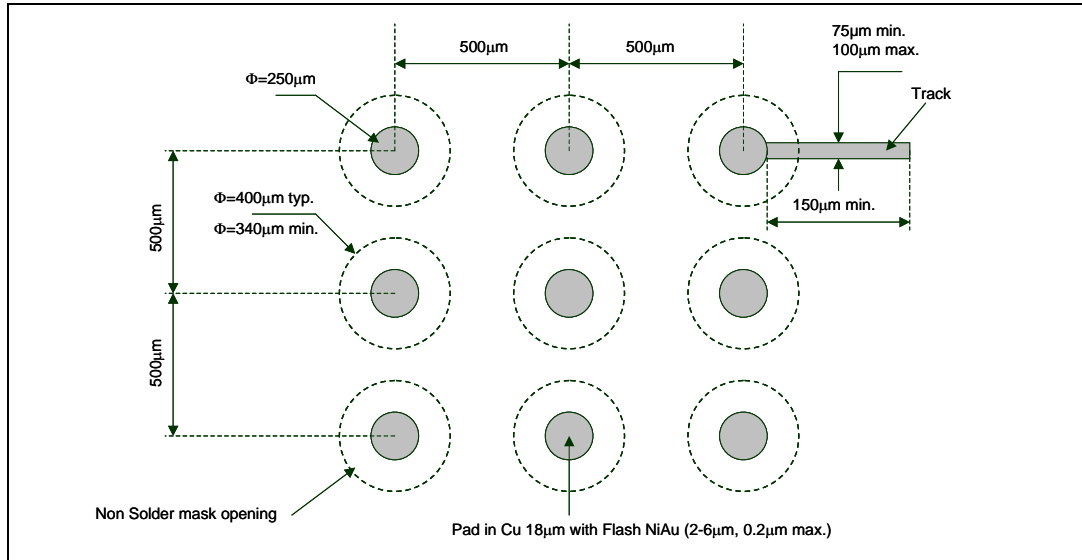

7 Package information

In order to meet environmental requirements, ST offers these devices in different grades of ECOPACK[®] packages, depending on their level of environmental compliance. ECOPACK[®] specifications, grade definitions and product status are available at: www.st.com. ECOPACK[®] is an ST trademark.

Figure 67. Pin-out for 9-bump flip-chip (top view)

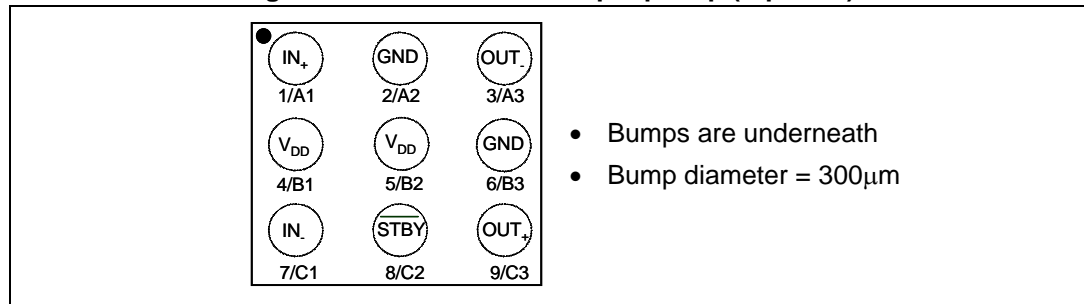

Figure 68. Marking for 9-bump flip-chip (top view)

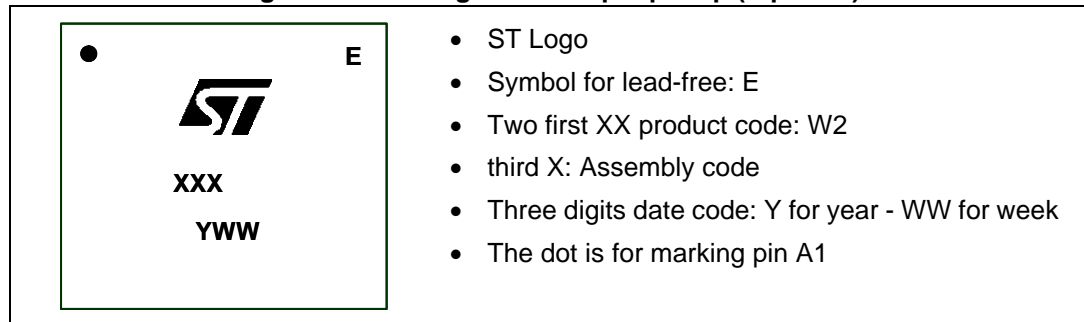
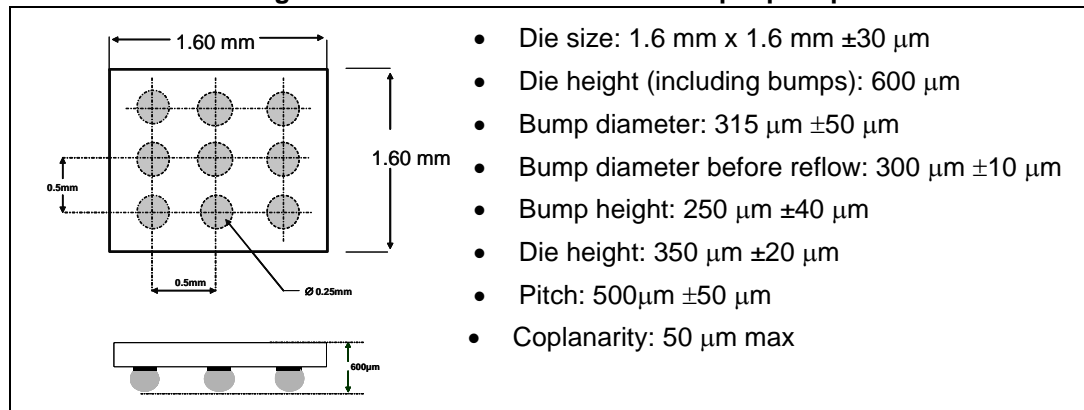

Figure 69. Mechanical data for 9-bump flip-chip



8 Revision history

Table 11. Document revision history

Date	Revision	Changes
06-Mar-2014	1	Initial release.

Please Read Carefully:

Information in this document is provided solely in connection with ST products. STMicroelectronics NV and its subsidiaries ("ST") reserve the right to make changes, corrections, modifications or improvements, to this document, and the products and services described herein at any time, without notice.

All ST products are sold pursuant to ST's terms and conditions of sale.

Purchasers are solely responsible for the choice, selection and use of the ST products and services described herein, and ST assumes no liability whatsoever relating to the choice, selection or use of the ST products and services described herein.

No license, express or implied, by estoppel or otherwise, to any intellectual property rights is granted under this document. If any part of this document refers to any third party products or services it shall not be deemed a license grant by ST for the use of such third party products or services, or any intellectual property contained therein or considered as a warranty covering the use in any manner whatsoever of such third party products or services or any intellectual property contained therein.

UNLESS OTHERWISE SET FORTH IN ST'S TERMS AND CONDITIONS OF SALE ST DISCLAIMS ANY EXPRESS OR IMPLIED WARRANTY WITH RESPECT TO THE USE AND/OR SALE OF ST PRODUCTS INCLUDING WITHOUT LIMITATION IMPLIED WARRANTIES OF MERCHANTABILITY, FITNESS FOR A PARTICULAR PURPOSE (AND THEIR EQUIVALENTS UNDER THE LAWS OF ANY JURISDICTION), OR INFRINGEMENT OF ANY PATENT, COPYRIGHT OR OTHER INTELLECTUAL PROPERTY RIGHT.

ST PRODUCTS ARE NOT DESIGNED OR AUTHORIZED FOR USE IN: (A) SAFETY CRITICAL APPLICATIONS SUCH AS LIFE SUPPORTING, ACTIVE IMPLANTED DEVICES OR SYSTEMS WITH PRODUCT FUNCTIONAL SAFETY REQUIREMENTS; (B) AERONAUTIC APPLICATIONS; (C) AUTOMOTIVE APPLICATIONS OR ENVIRONMENTS, AND/OR (D) AEROSPACE APPLICATIONS OR ENVIRONMENTS. WHERE ST PRODUCTS ARE NOT DESIGNED FOR SUCH USE, THE PURCHASER SHALL USE PRODUCTS AT PURCHASER'S SOLE RISK, EVEN IF ST HAS BEEN INFORMED IN WRITING OF SUCH USAGE, UNLESS A PRODUCT IS EXPRESSLY DESIGNATED BY ST AS BEING INTENDED FOR "AUTOMOTIVE, AUTOMOTIVE SAFETY OR MEDICAL" INDUSTRY DOMAINS ACCORDING TO ST PRODUCT DESIGN SPECIFICATIONS. PRODUCTS FORMALLY ESCC, QML OR JAN QUALIFIED ARE DEEMED SUITABLE FOR USE IN AEROSPACE BY THE CORRESPONDING GOVERNMENTAL AGENCY.

Resale of ST products with provisions different from the statements and/or technical features set forth in this document shall immediately void any warranty granted by ST for the ST product or service described herein and shall not create or extend in any manner whatsoever, any liability of ST.

ST and the ST logo are trademarks or registered trademarks of ST in various countries.

Information in this document supersedes and replaces all information previously supplied.

The ST logo is a registered trademark of STMicroelectronics. All other names are the property of their respective owners.

© 2014 STMicroelectronics - All rights reserved

STMicroelectronics group of companies

Australia - Belgium - Brazil - Canada - China - Czech Republic - Finland - France - Germany - Hong Kong - India - Israel - Italy - Japan - Malaysia - Malta - Morocco - Philippines - Singapore - Spain - Sweden - Switzerland - United Kingdom - United States of America

www.st.com

